

RoeTest V11
professional tube testing system
(c) Helmut Weigl
Frontpanel design and adapter boxes 'A'

As of: 06/2026

Introduction to this manual:

Building the RoeTest tube tester is not a project for beginners. In addition to the size and complexity of the project, this tube tester works **with high and lethal voltages**. Experience is required. I recommend that you only try to build this tester if you have ample knowledge of and experience with electronics.

That said, the tube tester can be built successfully as shown by the many testers built by other people. You can see these on the website. The manuals appear to be complete and correct, I would be grateful if you would let me know if you find errors in the manuals or if you have improvement suggestions.

Disclaimer:

THE ROETEST CIRCUIT DESIGNS, HARDWARE, SOFTWARE OR ANY OTHER MATERIAL ARE PROVIDED BY ME "AS IS" AND ANY EXPRESS OR IMPLIED WARRANTIES, INCLUDING, BUT NOT LIMITED TO, THE IMPLIED WARRANTIES OF MERCHANTABILITY AND FITNESS FOR A PARTICULAR PURPOSE ARE DISCLAIMED. IN NO EVENT SHALL I BE LIABLE FOR ANY DIRECT, INDIRECT, INCIDENTAL, SPECIAL, EXEMPLARY, OR CONSEQUENTIAL DAMAGES (INCLUDING, BUT NOT LIMITED TO, PROCUREMENT OF SUBSTITUTE GOODS OR SERVICES; LOSS OF USE, DATA, OR PROFITS; OR BUSINESS INTERRUPTION) HOWEVER CAUSED AND ON ANY THEORY OF LIABILITY, WHETHER IN CONTRACT, STRICT LIABILITY, OR TORT (INCLUDING NEGLIGENCE OR OTHERWISE) ARISING IN ANY WAY OUT OF THE USE OF THE CIRCUIT DESIGNS, HARDWARE OR SOFTWARE, EVEN IF ADVISED OF THE POSSIBILITY OF SUCH DAMAGE.

I hereby exclude liability of any kind. I do not guarantee the functionality or suitability of the software, the circuits or any of the documents I have made available. Any reproduction is at your own risk. In particular, software is never completely free of errors, which could also lead to malfunctions. Tubes or the device can also be damaged if the device is operated incorrectly. Liability for consequential damage is excluded (e.g. destroyed tubes, components, property damage, personal injury due to electric shock, etc.). The device must never be operated without supervision.

Lethal and high voltages:

Tubes and tube testers including the RoeTest work with high and lethal voltages. Please note that working with high voltages is dangerous. The voltages in the tube tester and also on the tube socket's pins are dangerous and can lead to injury or death. Use with care. Ensure the RoeTest is only used by adults with knowledge of vacuum tubes and electronics. Keep away from children and animals. You and anyone using the tube tester are responsible for making sure you meet all the nationwide and local safety regulations.

Please remember that charged capacitors, in a power supply, will remain charged to high voltages for a long time after being switched off or disconnected from the mains, despite the use of bleeder resistors. Please discharge these capacitors with a suitable resistor before working on or experimenting with the circuits!

The RoeTest is a do-it-yourself (DIY) project. The RoeTest is not UL/CE/GS/Tüv tested or listed and I cannot guarantee that use of the RoeTest is legal or permitted.

Changes may be made to the software or hardware at any time. Compatibility with earlier versions is not guaranteed, even when current versions are compatible with earlier versions.

Note related to the tube data database:

The extensive tube data database is constantly changing. Tube data is added, changed and/or deleted. Current tube data may be wrong or incomplete. No warranties are provided as to the completeness and/or correctness of the tube data. The database does contain data for tubes that the RoeTest cannot test, either because the required voltages or currents are too high or because they are for certain tubes for special applications.

Copyright:

Copyright Helmut Weigl, Heidestr. 7, 92708 Mantel, email info@roehrentest.de. I maintain all rights to the hardware, hardware designs and software. The software, hardware designs or any other material remain my intellectual property. You merely obtain a license to use the hardware designs, software or any other material for private use only.

The database is made available for private use only and it is not allowed to change the data structure and/or to remove any copyrights. It is not permitted to retrieve the data for in other applications then the RoeTest tube tester. .

If you purchase a license, I allow commercial use of the software, databases, or hardware manufactured based on my documents for measuring tubes that are to be sold.

The construction and sale of devices or parts for profit is not permitted. In this case, my permission to issue a "separate license" must be obtained.

You are not allowed to give the PCB designs and layouts to third parties without my consent, even if you did not change anything. You may only send these to a PCB manufacturer for the purpose of ordering PCBs for own use. It is not allowed to resell these PCBs.

The firmware for the PIC-Microcontroller can only be obtained from me, in the form of an already programmed PIC Microcontroller chip. Copying and distribution of the software and firmware is not allowed. The PIC-Microcontroller has a firmware read protection that may not be disabled in any way.

When you print RoeTest test results you may not remove the copyright marks.

Many of the socket images used by the RoeTest software are provided by Mr. Franz Hamberger. Mr. Hamberger makes these images available for private use on his website. The internet address for Mr. Hamberger's website is: <http://www.dl7avf.info/charts/roehren/index.html>.

Distribution of these images is only allowed under the conditions described on Mr. Hamberger's website.

Trademark protection

The Roehrentest logo is registered with the German Patent and Trademark Office as a protected trademark with the number 302021244050:

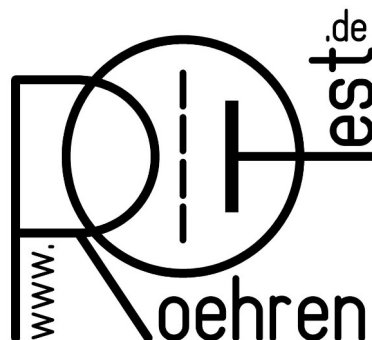

The word/image mark is therefore subject to trademark protection. I reserve all rights to it.

Changes V11 compared to V10:

There were also several versions of the V10. In principle, the V11 is also a V10 (same as V10.1R4). Due to the amount of changes it is time to change the version number again.

There are hardly any changes compared to the last V10. There is an additional TVS diode on the mainboard. Some other voltage regulators are used and some circuit boards have been relocated.

There is an additional relay on the G1 circuit board, which I have already described for retrofitting the V10.

Available voltages and currents:

Voltage source	Range [V]	Max. current [mA]	Continuous current [mA]	Resolution [V]
H	0-15	6000	5000	0,05
	15-20	2000	2000	
	0-115	600	500	
A	0-300	300	250	0,1
	300-600			
G1	0-100 (-)	5	5	0,025
G2	0-300	60	50	0,1
G3	0-100 (-)	5	5	0,025

Connectors on front panel:





Caution: There could be dangerous voltages up to 600V DC on the connectors.

Please use only well isolated wires to the top caps of the tubes. **Do not connect headphones or amp inputs directly to the RoeTest.** Use a output transformer which is qualified for high voltages and currents.

Functional description:

The RoeTest uses a USB interface to connect to a PC. A PIC microcontroller receives commands from the PC software and executes these. The PIC microcontroller controls the output voltages of the heater (H), anode a.k.a. plate (A), G1, G2 and G3 voltage boards and a matrix of relays to connect tube pins to the voltage sources. The PIC continuously measures voltages and currents and sends these back to the PC software for display and analysis. The PIC also supports functions such as checking for continuity and controlling an external heater voltage relay. To be able to increase the anode voltage there is a 600V board, which is a constant 300V voltage source, connected in series with the anode voltage board.

Block diagram:

The 5 voltage sources are shown in the block diagram below. The 5 voltage sources and ground are connected to 6 rails. The tube pins are then connected to the rails using a matrix of relays. The relay matrix consists of 10 cards each with 6 relays. In addition there are supplies for +5V, +9V, -12V, -105V, +330V and +12V (unstabilized, for the relays) on the motherboard for the various circuits.

Blockschaltbild RoeTest-Hardware

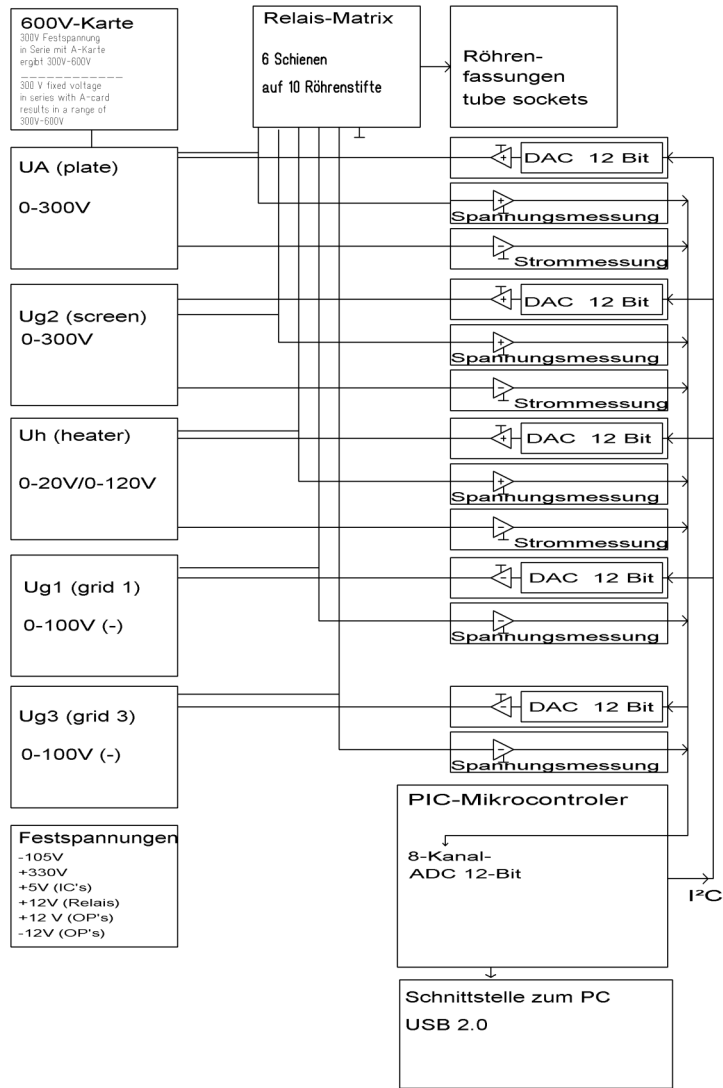

Circuit description:Supply voltages:

The relay voltage is not stabilized.

The +5 and +9, -12V sources need to be very stable and for that reason precision voltage regulators with low temperature drift are used. The absolute voltage output is less important than the stability since only voltage **variations** would result in measurement errors. In front of the 5V regulator is a 6,5V regulator. It minimizes power loss and temperature drift of the 5V regulator.

The additional +330V and -105V sources are stabilized using LR8 integrated circuits.

Variable voltage sources for the heater, anode (plate) and G2 voltages:

These all function in a similar manner, as shown in the following simplified diagram:

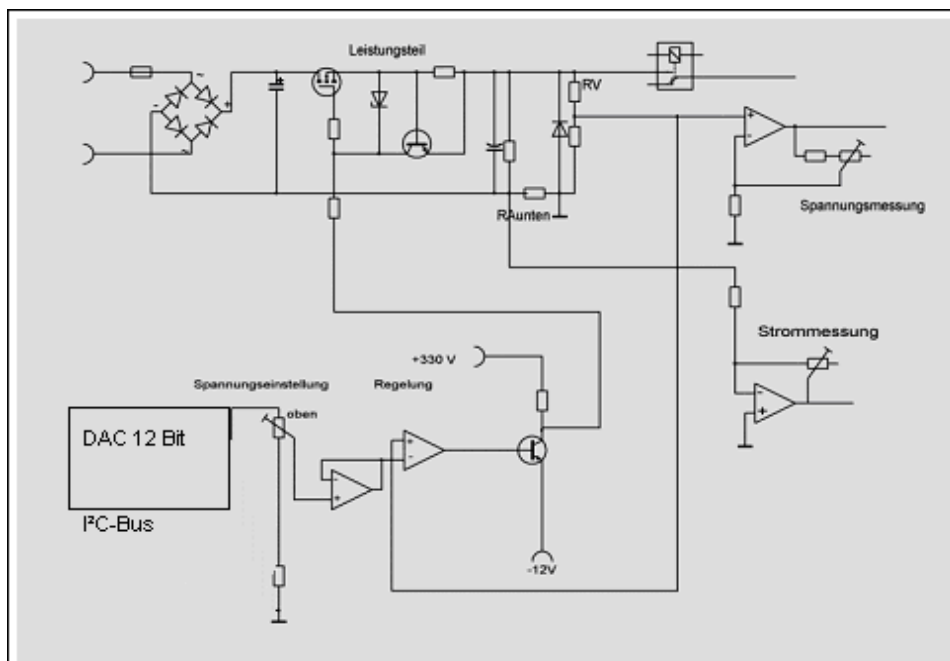

A D/A converter that is connected to the I²C-Bus is controlled by the PIC and generates a 0 to 4,7V voltage and that voltage is amplified using an opamp and a transistor. The H, A and G2 circuits use MOSFETs for increased power output.

The output is connected to a voltage divider around RV and the voltage measured at that point is fed back to a differential amplifier. This differential amplifier compares the voltages on its + and – inputs and keeps the output voltage constant (feedback loop). To make the circuit stable many circuit updates were necessary so the real circuit has quite a few more parts.

Finally the H, A and G2 circuits have a current limiter circuit: if the voltage drop over a resistor exceeds about 0.6 volts, a transistor is switched on to decrease the MOSFET output voltage such that the output current is limited.

Here is some more detail, please refer to the actual circuit diagrams (these are on a CD-ROM that can be obtained from me):

A voltage divider circuit is used to measure the voltage outputs of the voltage boards, and that voltage is fed into an opamp whose output is connected to an A/D converter input on the PIC microcontroller.

H, A and G2 output current is measured by measuring the voltage drop over resistors in the ground connections between the input voltage sources and central ground. For that, current is supplied by separate transformer circuits. Opamps are used again as amplifiers for the measured voltages and the output voltage is connected to an A/D converter input on the PIC microcontroller (see detailed circuit diagrams).

Board component dimensions and layout are different for each board. For the heater circuit low-high ranges, the transformer circuit and current limiter resistors are switched in two ranges by a relay.

Each board has a relay to connect the output to a relay matrix rail. The G2 board can also be connected over two 470K resistors to a rail, for testing magic eyes. The G1 board can be connected to a rail over a 1.2M resistor for tube vacuum testing. Relays are controlled by the PIC microcontroller using relay drivers on the PIC PCB or for the relay matrix cards by relay drivers on the relay matrix PCBs connected to the I²C-Bus.

LEDs and discharge resistors are used to discharge the electrolytic capacitors when the tube tester is switched off. The LEDs indicate whether the capacitors are still charged with a high voltage. For safety reasons you should only work on the tester when all electrolytic capacitors are discharged. The main PCB has various connection points that allow you to quicker discharge these capacitors e.g. using a light bulb, or that allow you to measure the voltage levels to verify the capacitors are discharged.

A high voltage opamp (LTC6090) is used for the G1 and G3 boards. See detailed circuit diagrams.

The G3 card also has a circuit to measure high voltages, and the circuit is active when the G3 card is not used for generating the G3 voltage. This is used e.g. when testing voltage stabilizers.

Boards:

There is a PCB for each of the 5 voltage sources. There is also a PCB for the PIC microcontroller (with relay drivers) and a PCB for the 600V range (this is a 300V fixed supply, which switched in serial to the anode card). Finally there are 10 PCBs for the relay matrix, each with relay drivers and I²C interface. As communication interface to the PC a USB card is present.

These PCBs are connected to and inserted into the main PCB.

The main PCB has the following circuits:

- Supply voltages
- Fuses and rectifiers, and the filter capacitors for the H, A and G2-voltages and the 600 V board
- Continuity checkers
- Relay for Soundtest
- connector socket for the PC interface board
- Soft start for the toroid main transformer using an NTC and a relay.

Ordering Components

1. I offer CD-Rom, programmed Pic microcontroller, PCB's, mains transformer and hard to get special components. Please ask me.
2. Normal elektronik components: There is a **components database** application for the RoeTest that can be downloaded or that can be found on the CD-ROM (directory Bauteileliste_Components). It lists all the parts and components needed for the RoeTest with the Reichelt order number (www.reichelt.de). You can print lists of components to order or you can save them as a csv file that can be uploaded to Reichelt (note: that import doesn't always work properly). You are responsible for ordering parts. I cannot be held responsible for wrongly ordered parts. There is a manual for the parts database application on the CD-ROM (Bauteile – Hilfe.pdf). The database has cost price information although you will need to verify and update the cost price information since the prices are constantly changing. You can add and delete components to/from the database, which may come in handy if you already have some components.
3. Frontpanel:
I had a number of front panels made (design A). This time in absolute professional quality with under anodized printing (scratch, wipe, solvent resistant, also against finger sweat). The lettering is embedded in the hard anodized layer and is completely smooth. The edges are also anodized. Whoever purchases the front panel from me saves an additional ordering process (and costs).

If you want to make changes to the front panel or make them yourself:

The CD contains drafts of the front panel (design 'A' - with socket box holder - and design 'C' - with connection socket -) by the front panel designer from Schaeffer AG. The front panel designer can be downloaded free of charge from the Schaeffer AG website (<http://www.schaeffer-ag.de>). In the USA there is the company Front Panel Express Inc. (<http://www.frontpanelexpress.com/>). With this you can change my front panel design and order the front panel from Schaeffer AG (or Front Panel Express Inc.) online. If you are able to do this, you can of course also manufacture the front board yourself, which is significantly cheaper. Please obtain the housing and heat sink before ordering / manufacturing the front panel. The external dimensions of the front panel, heat sink fastening, etc. must be adjusted beforehand.

Component selection:

I recommend using only first class components. If you're using second class components you should expect second class quality.

For tube sockets I recommend to use socket boxes and not to have fixed sockets.

Transformers:

I recommend to use only toroidal transformers. Toroidal transformers are more compact, lighter and more important, the difference between the output voltage under no load and full load is less!

In the device are two transformers: Main transformer and auxiliary transformer. Both transformers have two primary windings.

remarks assembling PCB

Auxiliary transformer

This transformer is to assemble onto the main board.

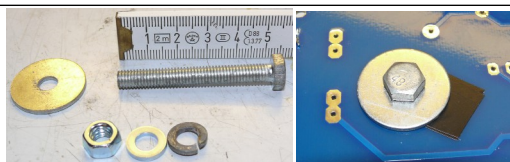

Please fasten the transformer's screw carefully. The colors of the secondary wires are printed on the PCB. For the primary connections see below.

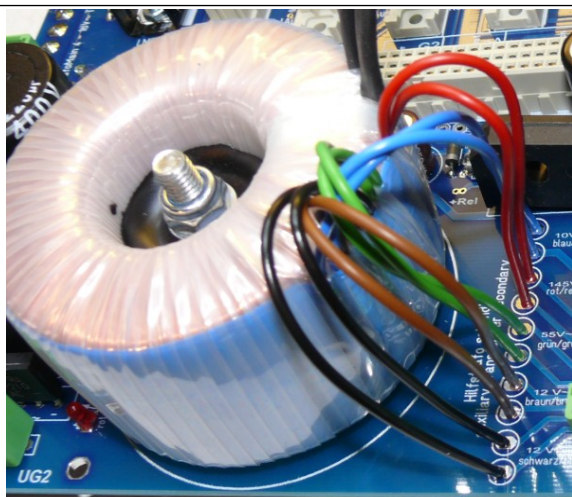

Secondary connections, the circuit board is labeled with the cable colors

Main Transformer (toroidal)

This is attached to the front panel.

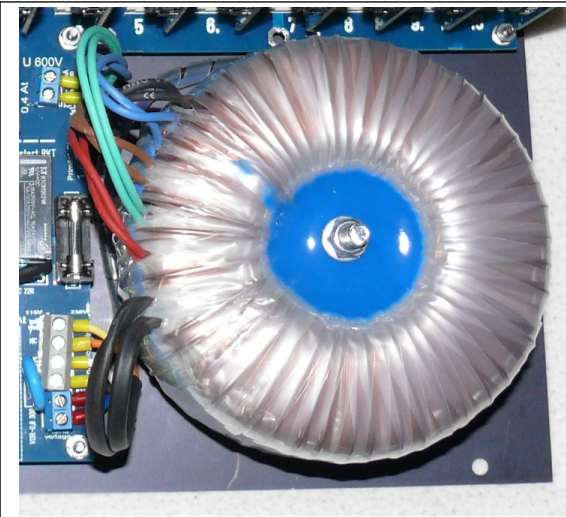

For the secondary connections of the main transformer please see below

Primary connections (all toroidal transformers):

There are two primary windings of 115V. These windings can be connected in series (230V) or in parallel (115V).

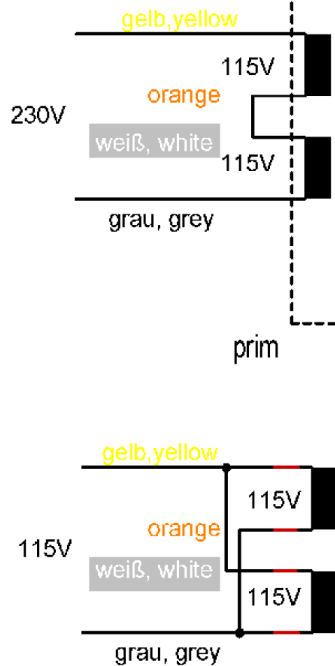

The colors of the wires for the primary windings are printed on main board (red = 230V, green = 115V):

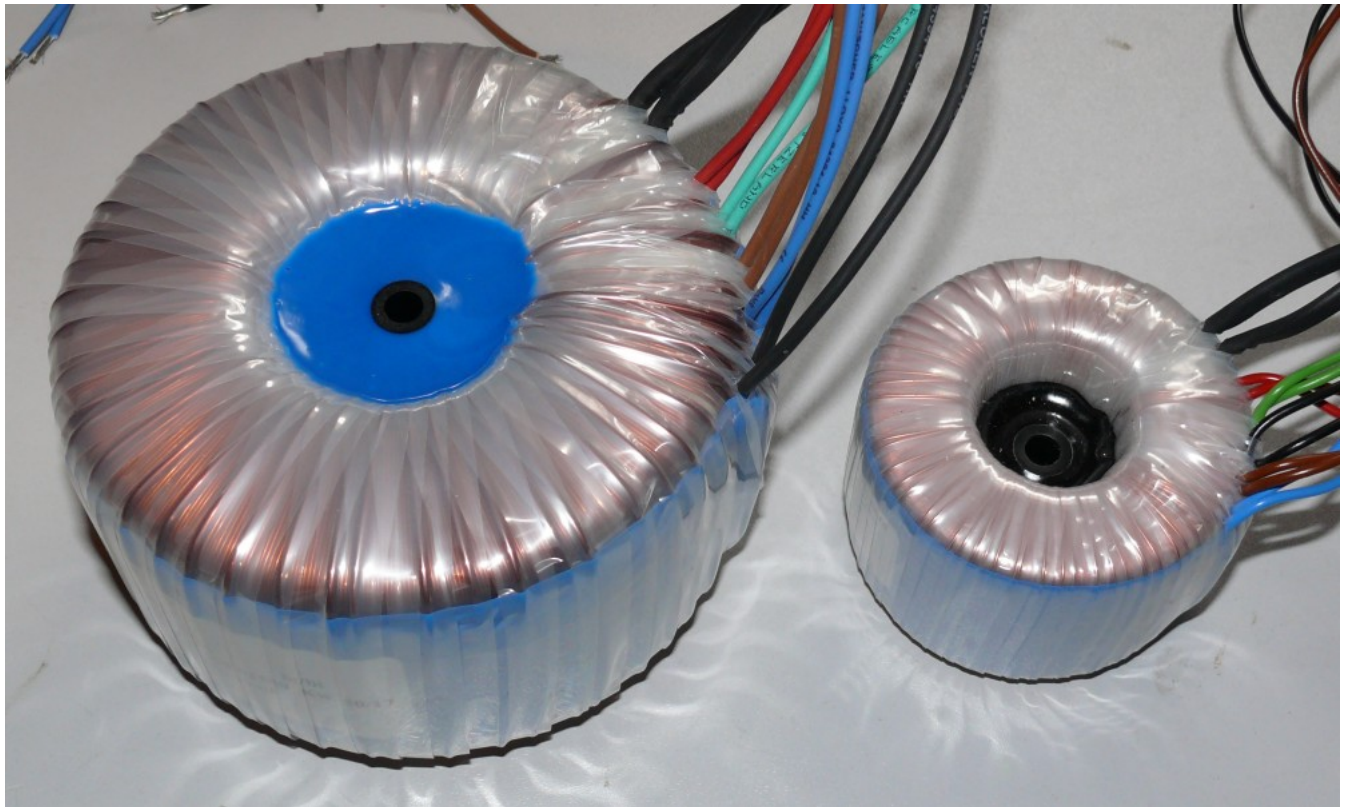
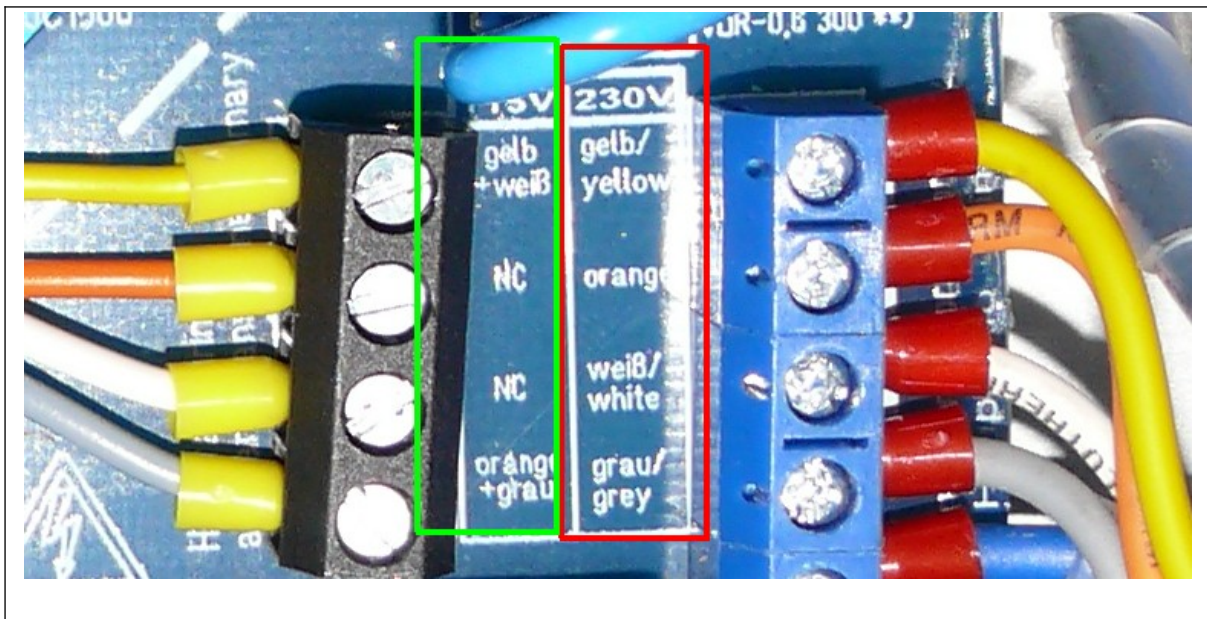

Main transformer and auxiliary transformer (made to specification, available from me)

For resistors please use metal film resistors (1%) and wire wound high wattage resistors (10%) where needed.

Trimmer pots should be good quality, multi-turn units. Low cost trimmers are very fragile and often exhibit poor quality. Handle with care and do not turn beyond limits. Consider Bourns or other good quality trimmers.

IC sockets: Instead of standard sockets, precision sockets with turned, gold-plated contacts are recommended.

DAC 121C085

This components are not market with its real name. They are marked as „xxxx X90C“. See data sheet:



PACKAGE OPTION ADDENDUM

6-Oct-2015

PACKAGING INFORMATION

Orderable Device	Status (1)	Package Type	Package Drawing	Pins	Package Qty	Eco Plan (2)	Lead/Ball Finish (6)	MSL Peak Temp (3)	Op Temp (°C)	Device Marking (4/5)
DAC121C081CIMK/NOPB	ACTIVE	SOT	DDC	6	1000	Green (RoHS & no Sb/Br)	CU NIPDAU	Level-1-260C-UNLIM	-40 to 125	X84C
DAC121C081CIMKX/NOPB	ACTIVE	SOT	DDC	6	3000	Green (RoHS & no Sb/Br)	CU NIPDAU	Level-1-260C-UNLIM	-40 to 125	X84C
DAC121C081CISD/NOPB	ACTIVE	WSON	NGF	6	1000	Green (RoHS & no Sb/Br)	CU SN	Level-1-260C-UNLIM	-40 to 125	X87
DAC121C081CISDX/NOPB	ACTIVE	WSON	NGF	6	4500	Green (RoHS & no Sb/Br)	CU SN	Level-1-260C-UNLIM	-40 to 125	X87
DAC121C085CIMM/NOPB	ACTIVE	VSSOP	DGK	8	1000	Green (RoHS & no Sb/Br)	CU SN	Level-1-260C-UNLIM	-40 to 125	X90C
DAC121C085CIMMX/NOPB	ACTIVE	VSSOP	DGK	8	3500	Green (RoHS & no Sb/Br)	CU SN	Level-1-260C-UNLIM	-40 to 125	X90C

Temperature sensor LM75



There are now better qualities. The STLM75M2F or the TMP1075DR with better accuracy and an automatic reset in the event of a bus timeout.

Test points

There are various test points on the main board and the plug-in cards. These have holes so that pointed probes do not slip. If, however, you want to connect a measuring cable, it is advisable to solder in soldering nails (e.g. Reichelt RTM 1-100).

Relays:

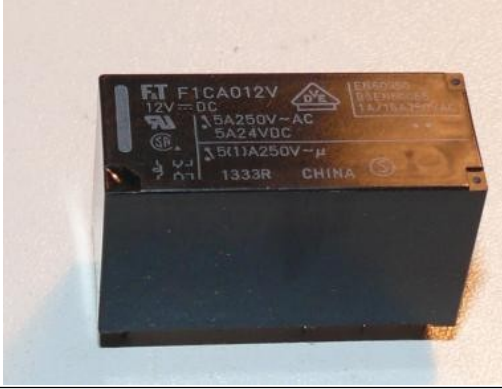
In the RoeTest, 3 different relay types are used:

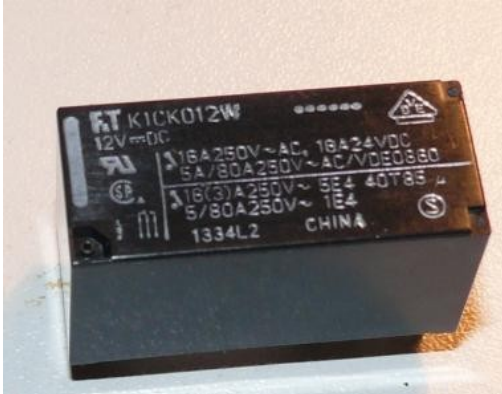
Type	Description	Where?	Picture
Type 1	2 pole, 400V, 5-8A, 12V Example: F1CL012R or F1CA012V (Height 16.5 mm)	Mainboard and voltage cards (at several places there is also the single pole type 3)	
Type 2	2 pole 250V, 2A, 12V Example: Omron G6S-2 12V (Reichelt)	Mainboard and voltage cards	
Type 3	1 pole, 400V, 16A, 12V Example: K1CK012W Note: This relay is slightly lower than type 1, max. height 15.7 mm (higher relays do not fit here)	Relay boards.	

PCF8574:

The relay boards can alternatively be equipped with

- SMD version (8 x PCF8574T and 2 x PCF8574AT) or the
- DIL version (8 x PCF8574N (= PCF8574P) and 2 x PCF8574AN (=PCF8574AP))

If the SMD version is used, the ICs must be soldered directly onto the circuit boards (do not use adapters, otherwise the distance from the blocking capacitors is too large)!

PCBs:

The double sided main PCB with many vias connecting different layers is very complex. It is also very large at 390 x 254 mm. This kind of PCB can hardly be made at home anymore. It would also be too expensive if everyone just had to have one made with a quantity of one. For that reason and also to protect my design I no longer distribute the PCB design files. You will find the schematics and the placement plans on CD-Rom.

I offer a quality PCB set, and you can buy them from me at a fair price.

These are professionally made PCBs:

- **Epoxy FR4**
- **2 mm for mainboard**
- **mainboard 70 μ copper thickness (others 35 μ)**
- **Double sided layers connected through**
- **Solder mask on both sides**
- **Silk screen print indicating component location on both sides**
- **HAL pre-tinned for easy soldering**

This table lists how many PCBs you need:

Application	Number
Main PCB	1
Relay matrix PCBs	10
Microcontroller	1
Voltages (A, G2, G3, H, G1, 600V)	6 (1 of each)
Temperature sensor	1
Interface card - USB	1

And this is what professionally made PCBs look like. Silk screening, solder mask and pre-tinning speed up component placing significantly.

Panel1:

The panel contains cutouts so that the different PCBs are connected via bars. The PCBs can simply be broken out.

The PCB size is 390 x 254 mm! Note: color (blue, green) and layout may differ from the pictures.

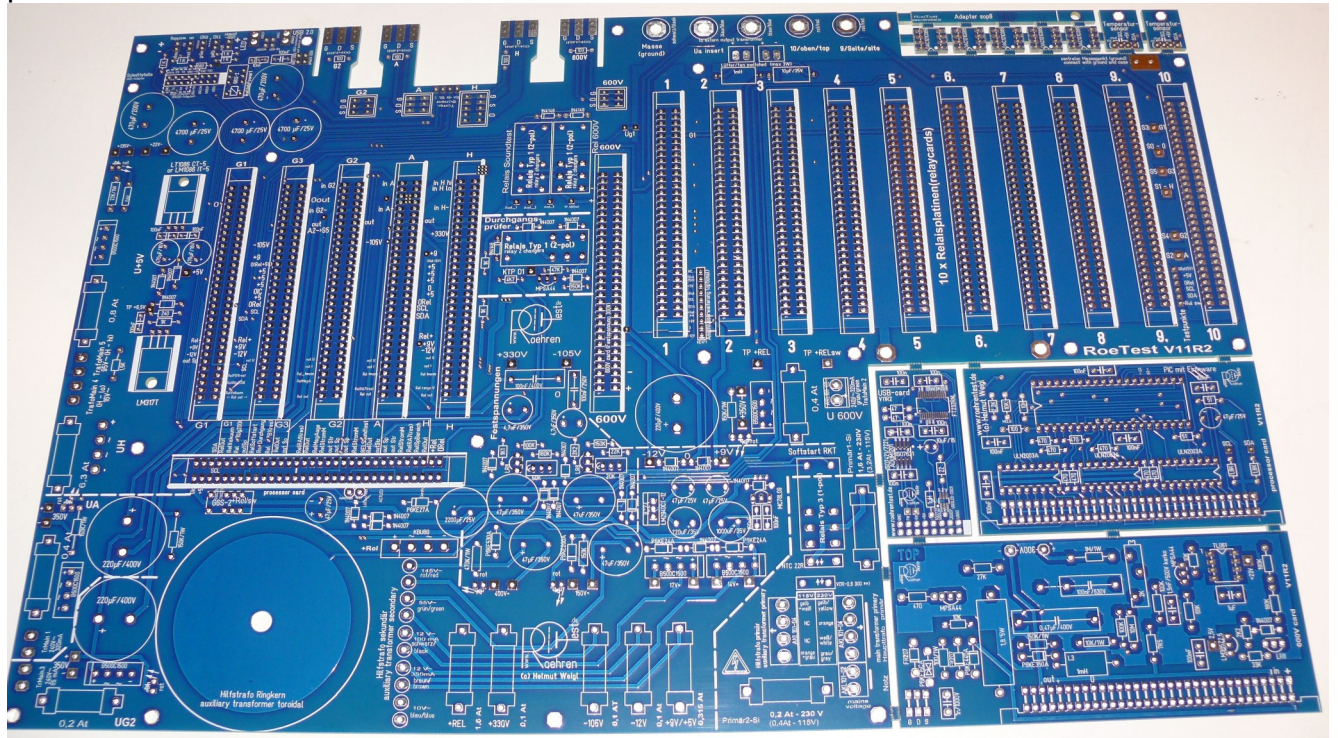

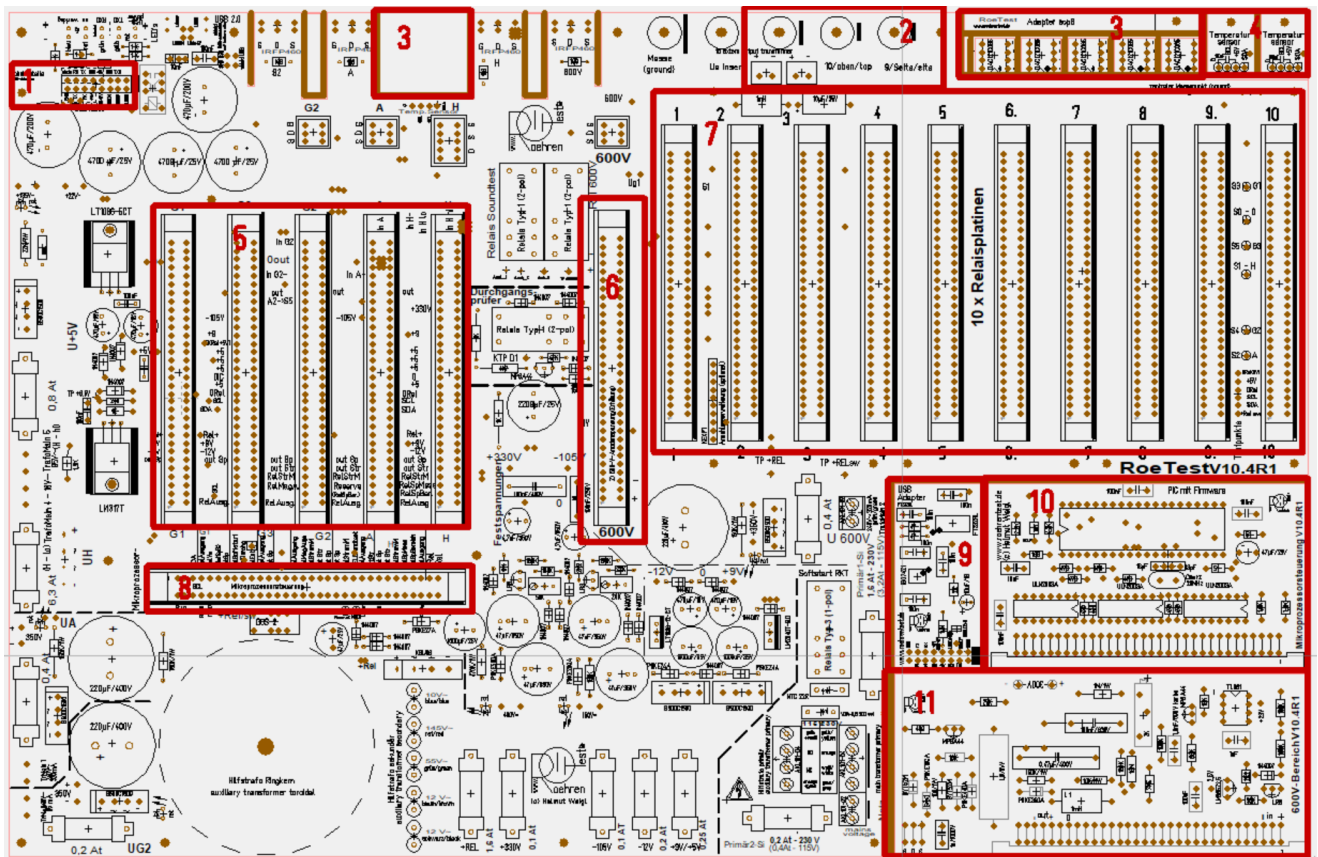

Description for panel „Hauptplatine“ (main board)

1. plug-in location for interface board
2. switched fan (depending on temperature sensor)
3. adapter board for DAC121C085 (for optional use)
4. temperature sensor PCB (only 1 piece needed)
5. plug-in locations for the voltage supply boards (H, A, G1, G2, G3)
6. plug-in location for 300V fixed voltage board (600V-range)
7. plug-in locations for the 10 relay boards
8. plug-in location for microprocessor board
9. USB interface PCB
10. Microcontroller PCB
11. 600V range PCB

Voltage PCBs: You can separate the 5 PCBs for instance by bending them on a table edge right at the PCB edges.

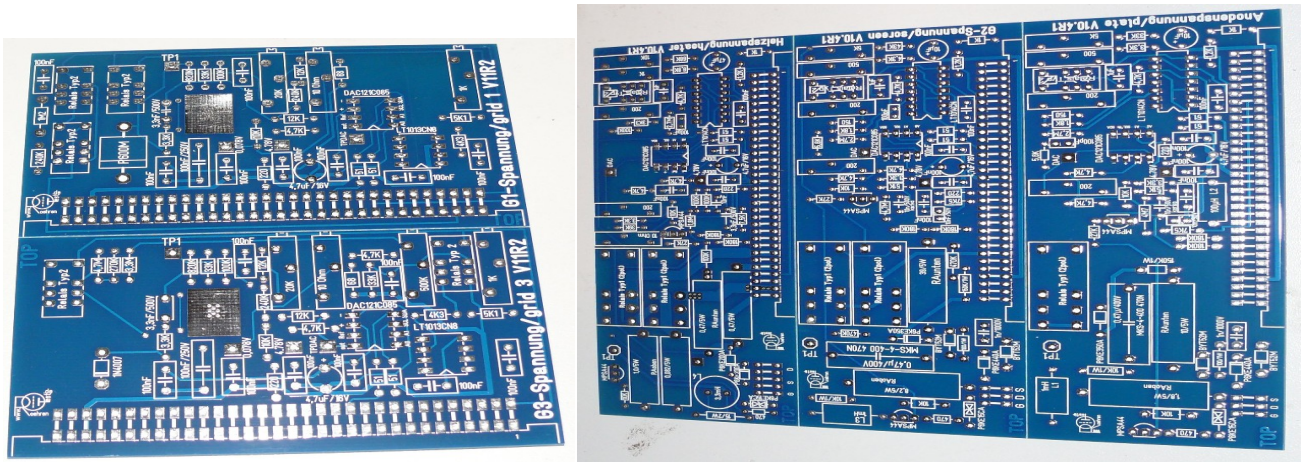

And finally the 10 relay matrix PCBs. You can separate the PCBs for instance by bending them on a table edge right at the PCB edges.

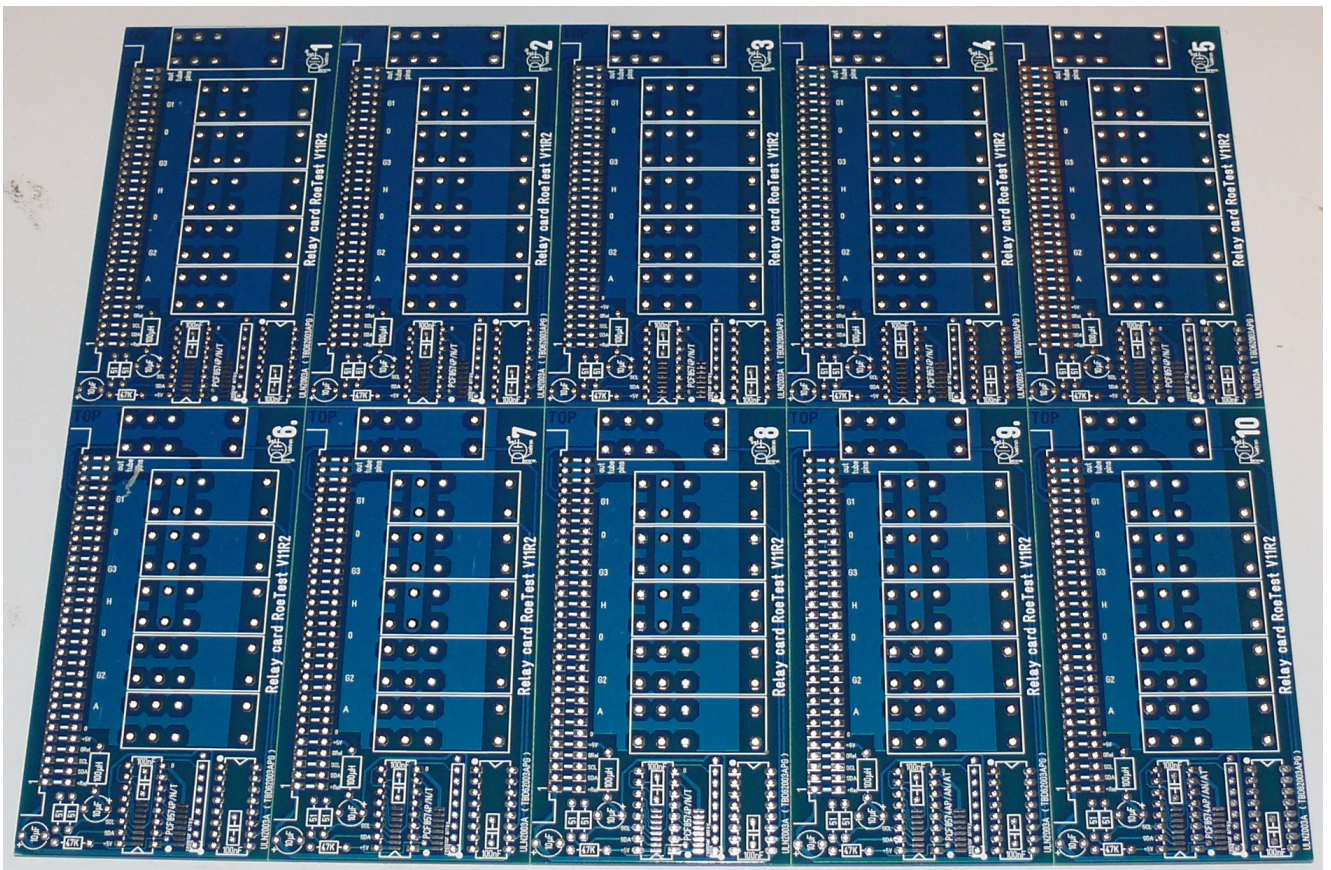

PCB assembling:

All PCBs have component placement silk screening. There are no bridges on the PCBs. Placement is simple. As usual start with mounting the low profile components. Although there are many components to mount this can be done quite quickly. Please do not attempt to establish speed records. You'd better mount components carefully.

HAL tinning (lead-free) ensures good solderability even when using leaded solder. For hobbyist usage leaded solder is allowed.

Main PCB

Please insulate the sections of the main PCBs that have traces directly connected to the mains, so you are protected from accidentally touching them.

When using the suggested front panel, coverage of the PCB's bottom side is achieved automatically. On the PCB's top side the life traces are mostly covered by components. Use enclosed fuse holders (touch guard).

Make sure you correctly orientate the 64 pin 4 mm PCB DIN connectors on the main PCB! (fat white lines indicate where the PCBs have to be plugged in). The female connectors on the mainboard have plug direction identification at their ends and must match the pluggable board's male connectors.

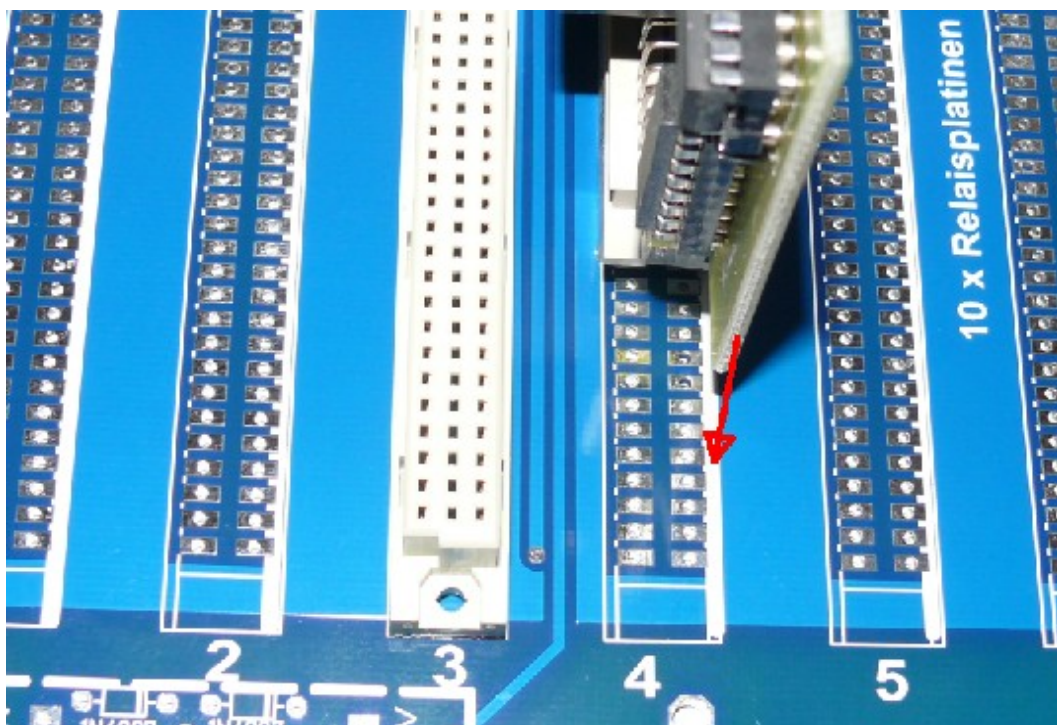

Additional connectors are needed for the A, G2, H and 600V PCBs and you can make these by using a saw to cut up a 64 pin 4mm PCB connector as shown below. You may have to glue the bottom piece back on on the separated pieces:

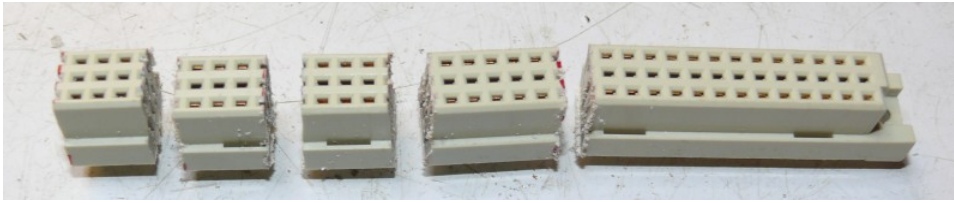

Best you cut the male and female connectors together:



remove the pins at the cutting position before cut

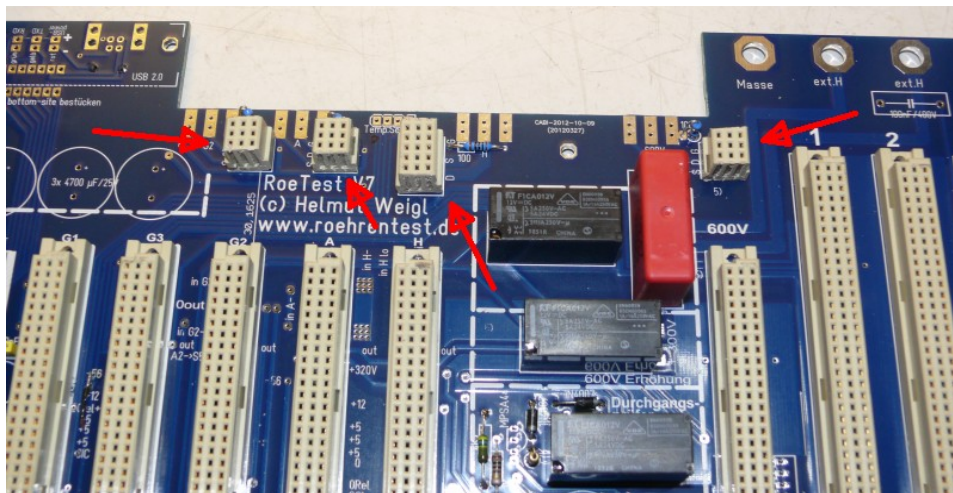

Fan

There are two connectors for fans provided on the main board. Both fans are controlled by the software. One fan is intended for case ventilation and the other one for the heat sink.

Both fans together must not consume more power than 3W (12V).

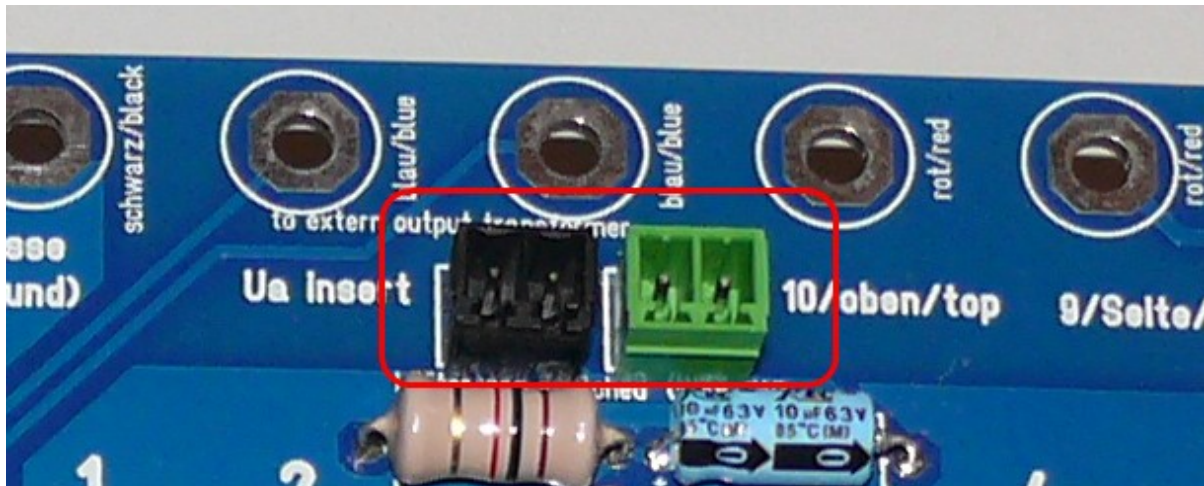

Picture of the main PCB: an industrially made PCB has many advantages over home made PCBs: silk screening, solder mask, double sided with vias, exact fit...all this just saves many hours of work, making it a good investment.

Top side of main PCB this allows alternatively mains voltages of 115V (110-120V) or 230V (220-240V) 50/60Hz.

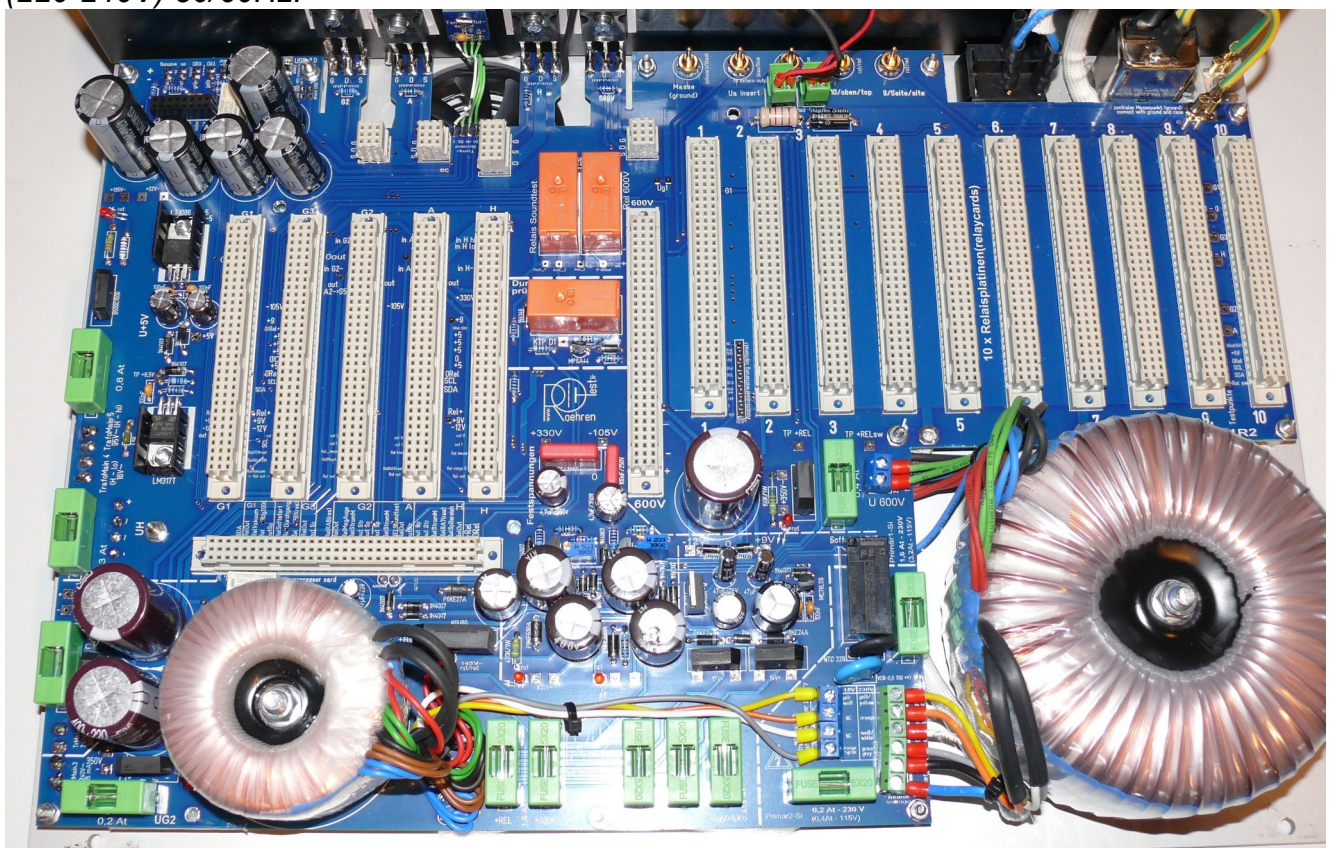

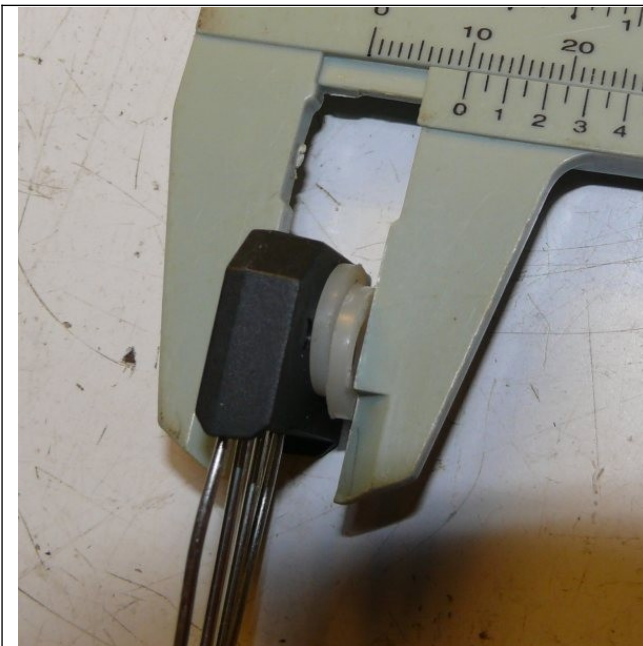

The bridge rectifier for the heater low voltage range (6A) **KBU808G** can deliver up to 8A if a heat sink is used. The front panel is used as the heat sink for this rectifier. For this purpose the component is mounted onto the bottom side of the main PCB. The distance between the main PCB and the front panel is 10 mm. The bridge rectifier is not that thick so plastic washers are put (glue it) between the rectifier and the PCB as shown to the left. Please use a little heat sink paste (aka thermal compound) between the bridge rectifier and the front panel. The screw for the main board is used to press the rectifier on to the front panel. Please solder the rectifier on both sites of the PCB.

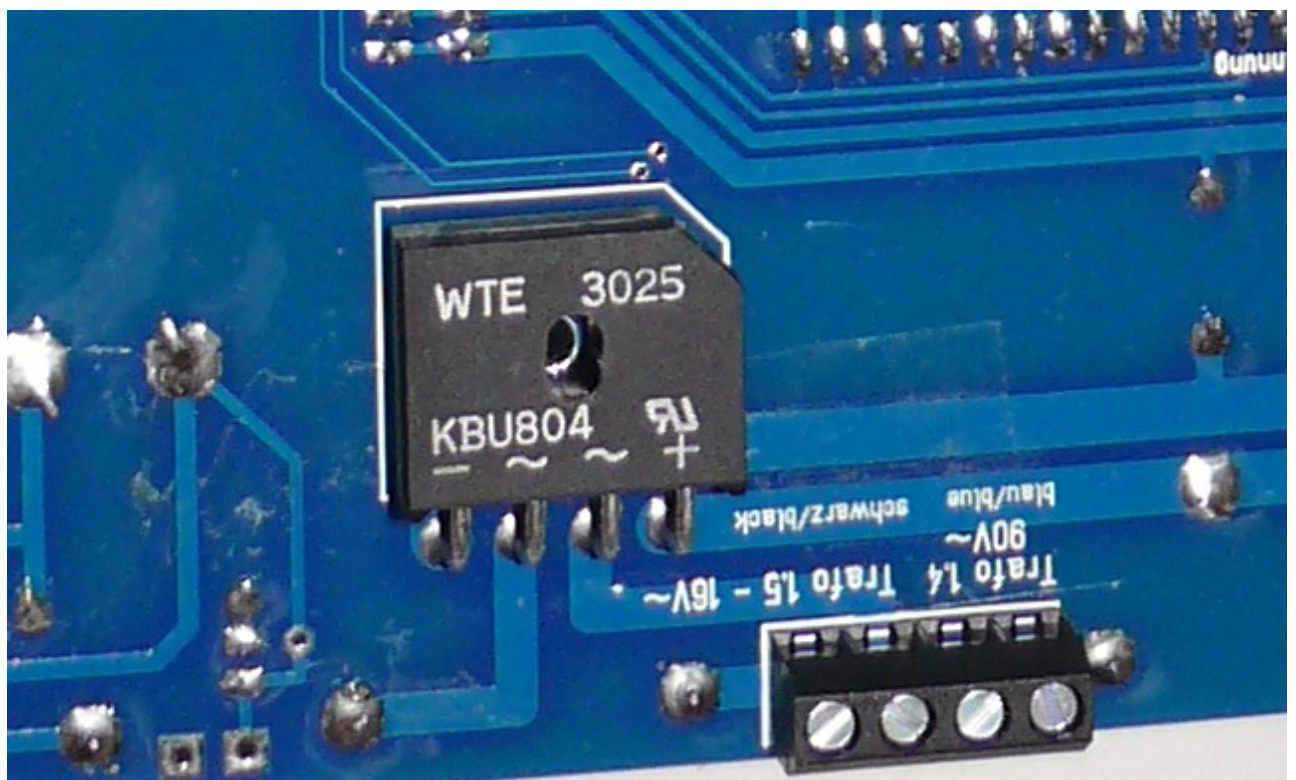
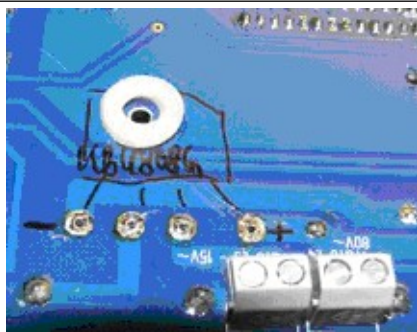

The 10 mm spacer is shown for comparison. At this location you don't need to use a spacer since the plastic washers and the bridge rectifier are effectively used as a 10 mm

Relay PCBs

- 10 of these need to be built (one PCB for each tube pin)

The I²C addresses are hardware programmed – you do that by connecting the address pins of the correct **IC types** (PCF8574 or PCF8574A) to either +5V (= 1) or 0V (= 0) as per the table below:

Tube pin/ PCB number	IC type	I ² C address (decimal)	A0 Pin1(IC)	A1 Pin2(IC)	A2 Pin3(IC)
1	PCF8574	64	0	0	0
2	PCF8574	66	1	0	0
3	PCF8574	68	0	1	0
4	PCF8574	70	1	1	0
5	PCF8574	72	0	0	1
6	PCF8574	74	1	0	1
7	PCF8574	76	0	1	1
8	PCF8574	78	1	1	1
9	PCF8574 A	112	0	0	0
10	PCF8574 A	114	1	0	0

On the finished boards that I provide these addresses are already set during the manufacturing process. Solder bridges are no longer required here. Please make sure that the right IC type is used.

It is possible to alternatively mount the SMD version (8 x PCF8574T, 2 xPCF8574AT) or the DIL version with IC socket (8 x PCF8574N or P and 2 x PCF8574AN or AP) on the PCBs.

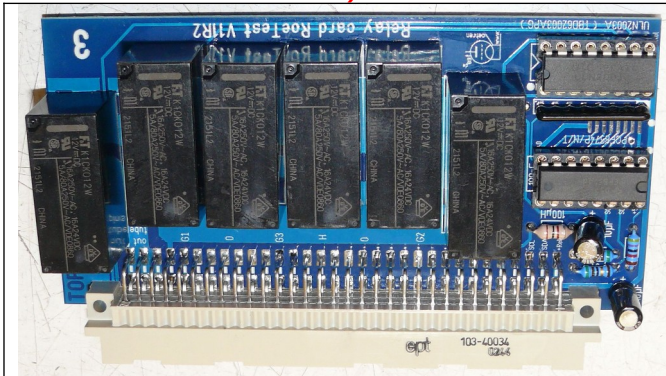

Dil-Version

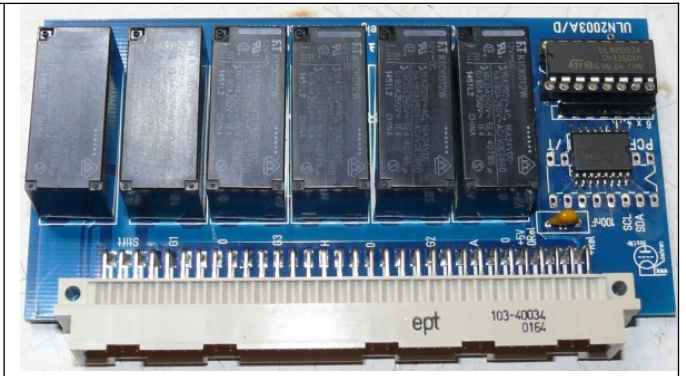

SMD-Version (picture of older PCB)

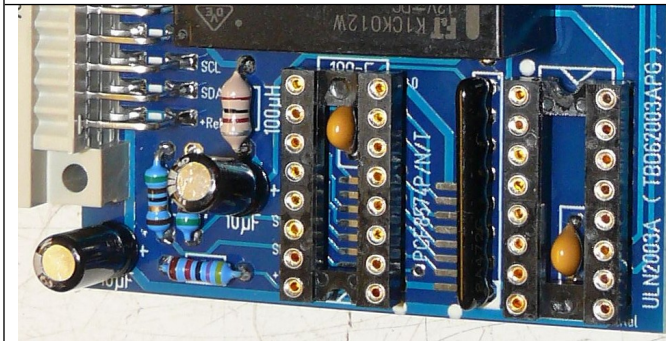

The ceramic capacitors must be soldered below the IC sockets.

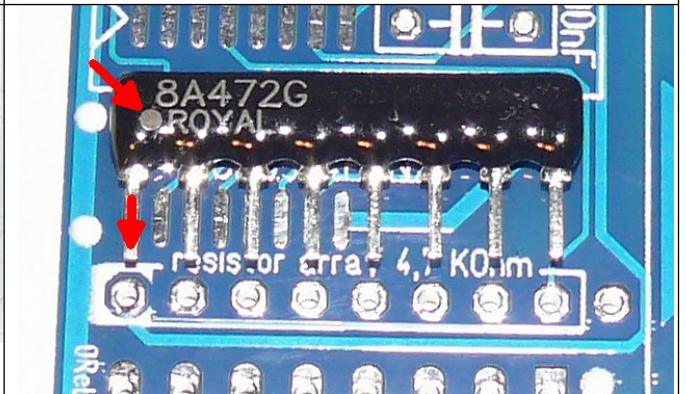

Assemble the resistor array facing the correct direction! If an array with 7 resistors isn't available, one with 6 or 8 resistors can also be installed. The eighth pin isn't connected anyway. The seventh pin leads to the interrupt output, which isn't used anyway.

Microcontroller PCB

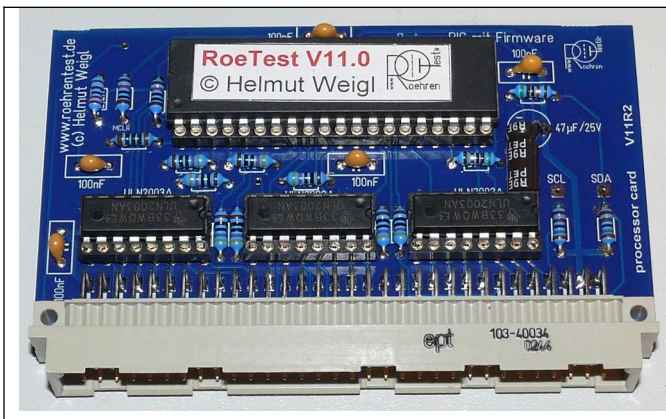

Microcontroller PCB RoeTest

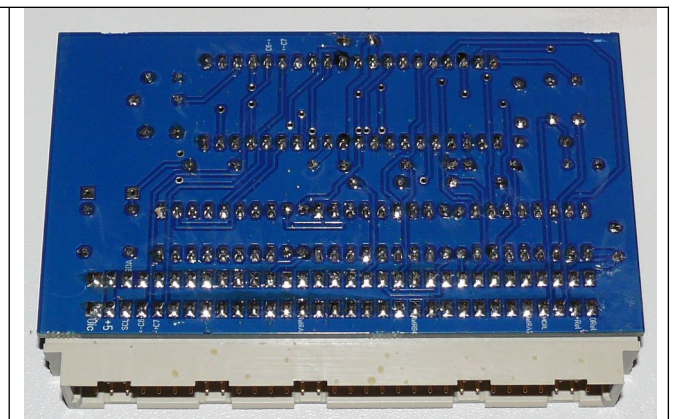

Heater voltage PCB

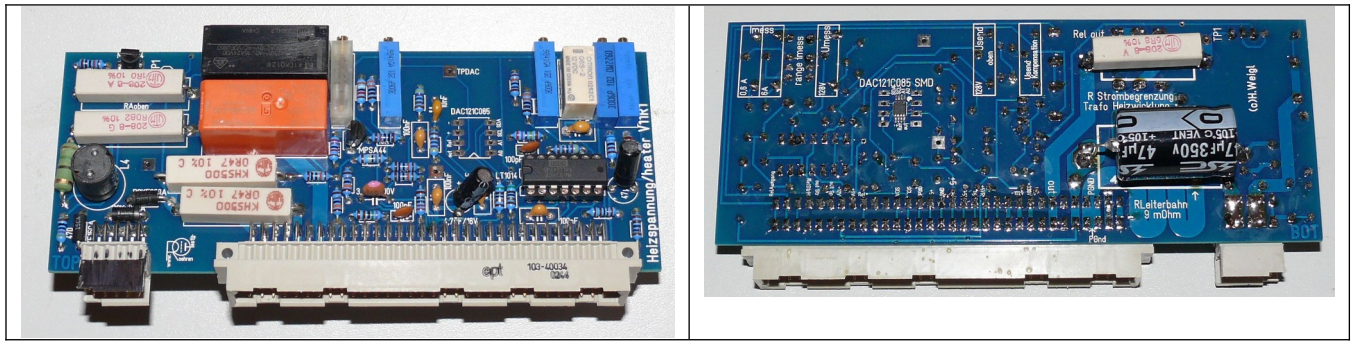

Also the following components need to be soldered on the PCB bottom side:

- 6,8-Ohm/5W resistor
- 47µF/350V electrolytic capacitor
- DAC121C085

Note for the DAC121C085: This IC may either be directly soldered to the bottom side of the PCB or mounted from the top side with a small **adapter PCB** and an IC socket – this applies to all voltage source PCBs.

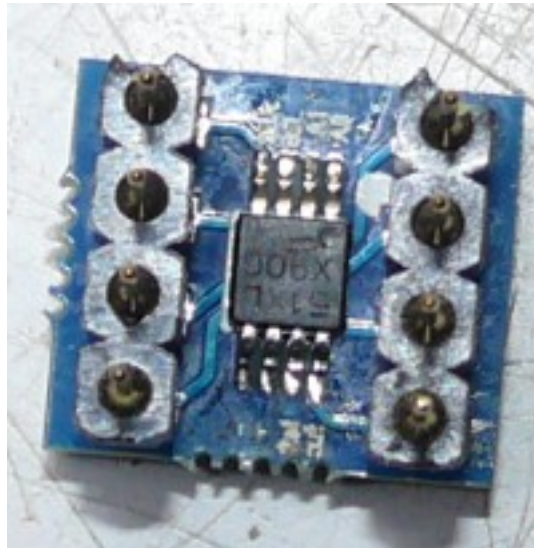

Anode (aka plate) voltage PCB

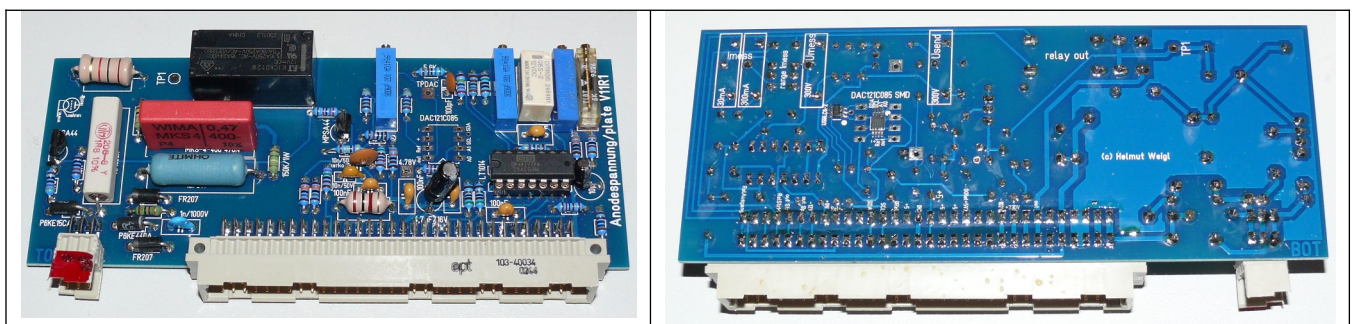

Please solder on the bottom site of the PCB the DAC121C085 and a USBLC6-2SC

G2 voltage PCB

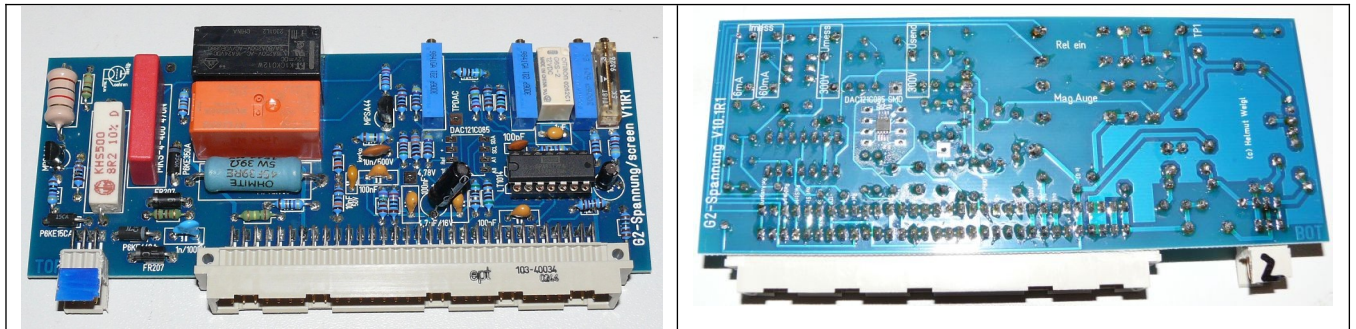

G1 voltage PCB

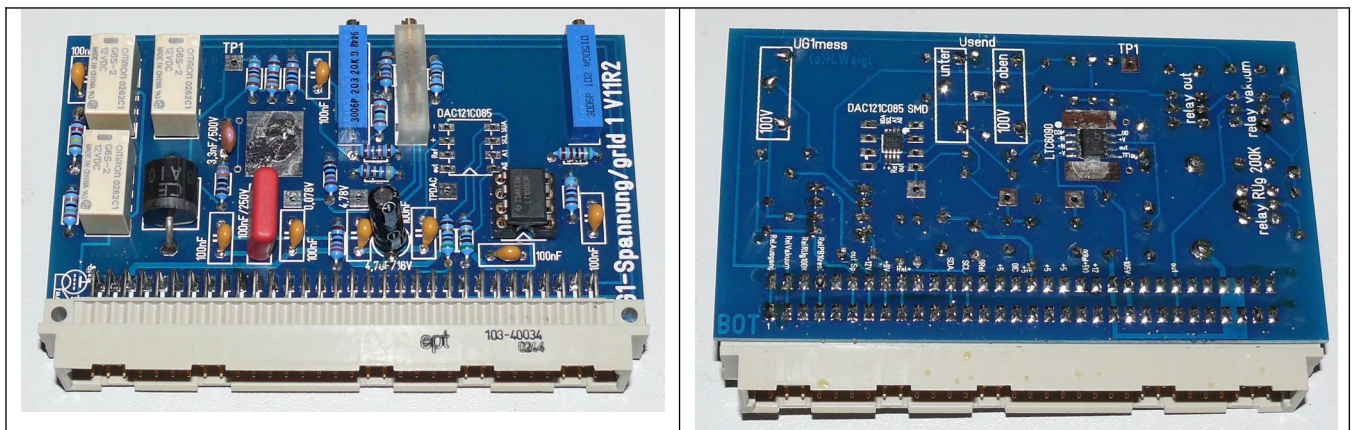

The LTC6090 is soldered on the PCB's bottom side. There is an exposed (thermal) pad on the bottom side of this IC that also must be soldered to the PCB (see hint: „Don't be afraid of SMD components“). This also applies for the G3 board.

G3 voltage PCB

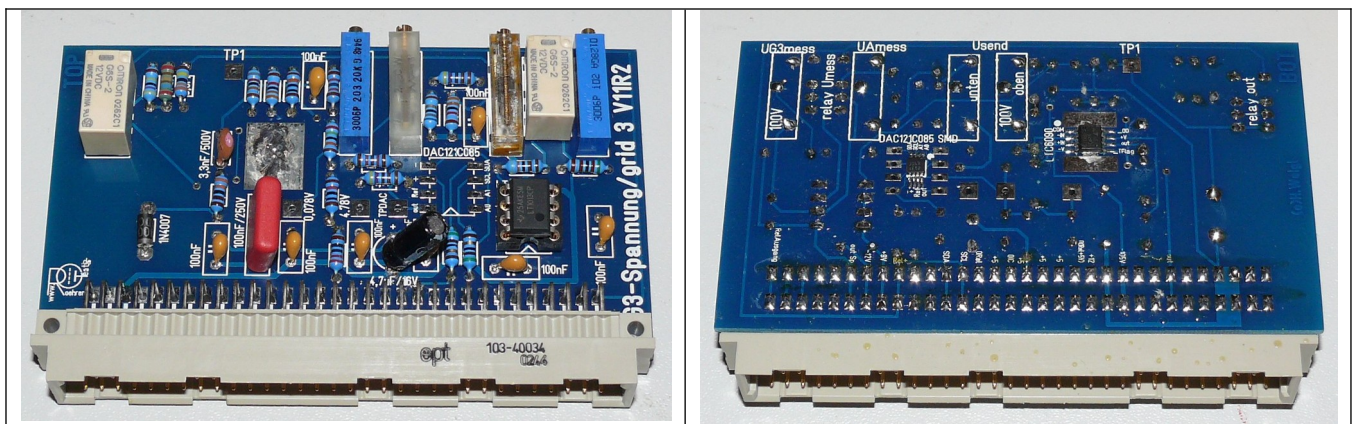

The G3 PCB from version 6 onwards has an additional function: if the board is not used to generate a G3 voltage it can be used to measure voltages up to 600V. For that purpose the PCB has an additional trimmer resistor for calibration purposes. This function is used for testing voltage stabilizer tubes.

11) 600V range PCB

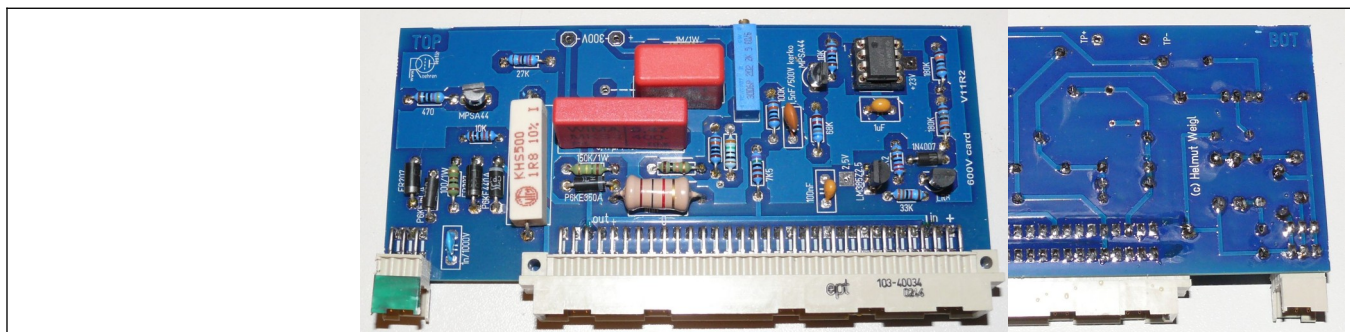

Here, please be sure to use a TL061 (this IC has very low power current consumption, neither TL081 nor TL071 are suitable here).

12) Temperature sensor PCB

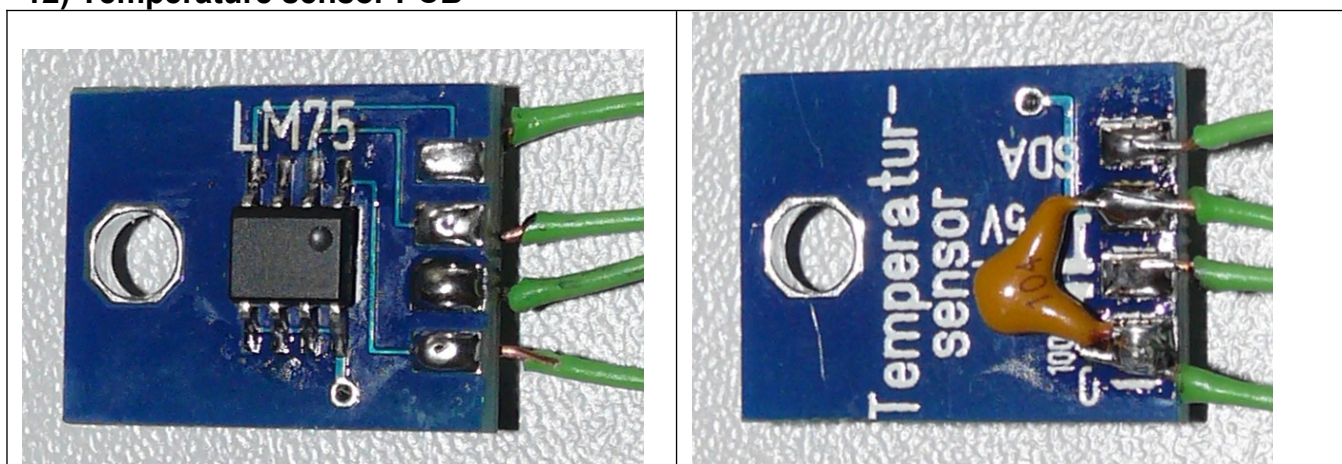

The circuit board is screwed onto the heat sink so that the temperature sensor touches it. It is best to spread some thermal paste between the temperature sensor and the heat sink. I insulate the connections with adhesive tape. I stick plastic washers to the screw hole so that the correct mounting distance is achieved. Tighten the screw on the heat sink carefully so that the temperature sensor is not damaged.



Instead of a standard LM75, a better temperature sensor such as the STLM75M2F or TMP1075DR can also be used. The STLM75M2F has no notch or marking for Pin1. Pin1 is in this print:

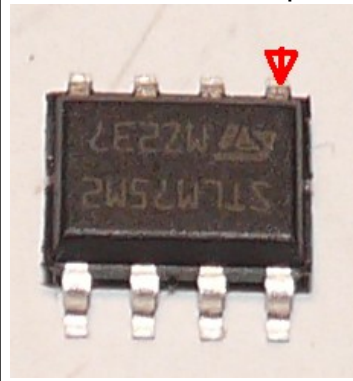

For the TMP1075 DR, Pin 1 is here:



13) USB interface:

These days USB is the standard for serial interfaces. USB 2.0 is used, the old USB 1.1 is too slow. Both your PC and the operating system must support USB 2.0 (Windows >= XP service pack 2 or higher).

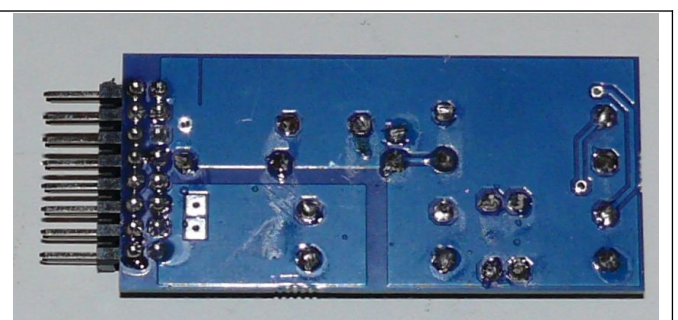
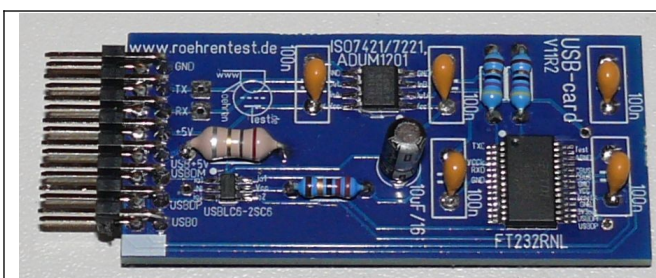

The USB interface is located on a **separate board that is plugged onto the mainboard**. USB female jack and the LEDs are located at the upper left edge of the mainboard.

Different types can be used for the isolator IC: ISO7221, ISO7421, ADUM1201 and others.

Important: Some components for the USB interface on the mainboard (jack, LEDs) are mounted on the bottom side of the mainboard, so that the LEDs and the USB jack protrude from the front panel. The mainboard must be mounted with 10mm distance on the backside of the front panel so that the USB jack sticks out a little from the front panel.

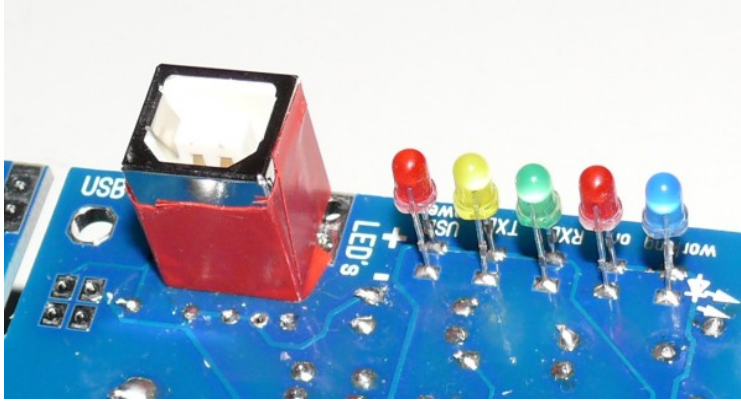

Isolate the metallic case of the USB jack from front panel with a tape (black).

For installing the software drivers for the USB interface

-> see: [USB card and installation D EN.pdf](#)

Very important: please always be sure to insert each PCB into the correct connector slot on the main PCB and don't put them in a wrong position as this will destroy the circuits. Don't insert or remove PCBs when power is switched on!

Socket box receiver – mechanical construction:

Tube sockets are not built in permanently, instead a socket box connector is used so that individual socket boxes can be connected.

Advantages:

- less risk of oscillations
- flexible, it's easy to add socket boxes for new tube socket types

Recommendations:

- use good quality connectors
- make sure to select an appropriate wire gauge/size for the expected currents
- use wire with good insulation
- **keep wire connections as short as possible.** Use RF attenuators made up of parallel connected RF chokes and 100 ohm resistors between each matrix card and its pin in the socket box receiver (Caution: Only use metal film resistors here, as they have low induction!)
- make sure all metal parts like screws or nuts are connected to ground (for safety reasons) or use plastic screws instead
- the best is to have socket boxes with only one tube socket each

I recommend 12 pin DIN41622 female connectors (*Reichelt FL B12, DIN41622*). 10 connections are used for the tube pins, one pin is used for ground and the remaining pin is connected to the heater voltage bar.

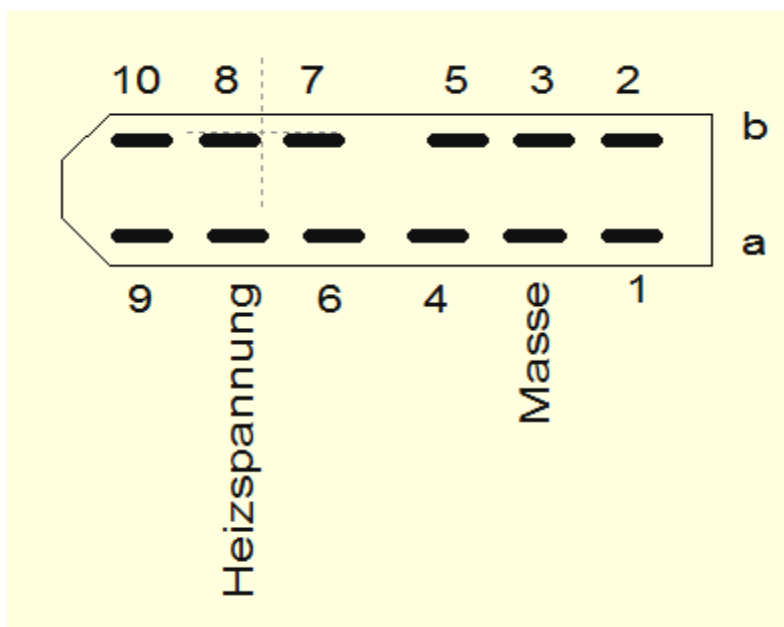

Connection diagram for the DIN 41622 connector (seen from the front on the socket box receiver)

Connector for socket box receiver:

Use RF attenuators for the 10 pins. Don't use ferrite beads for the ground (yellow/green) and heater (red) connections. The connector is positioned on the bottom of the mainboard and all cables are soldered in place. The connector is then inserted through the recess in the front panel.

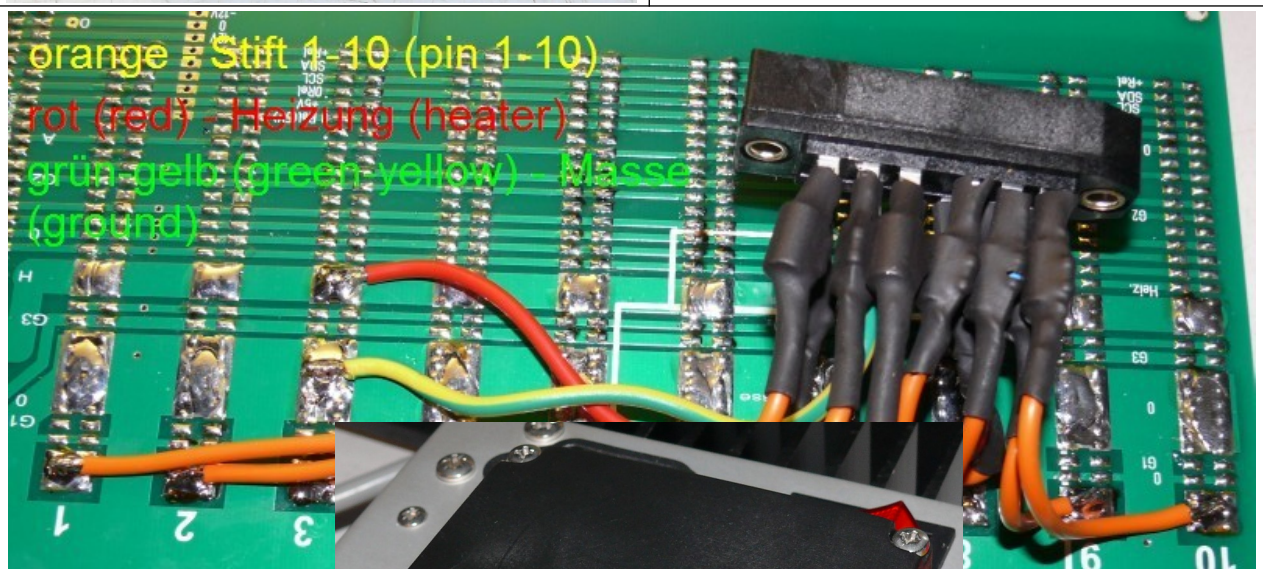
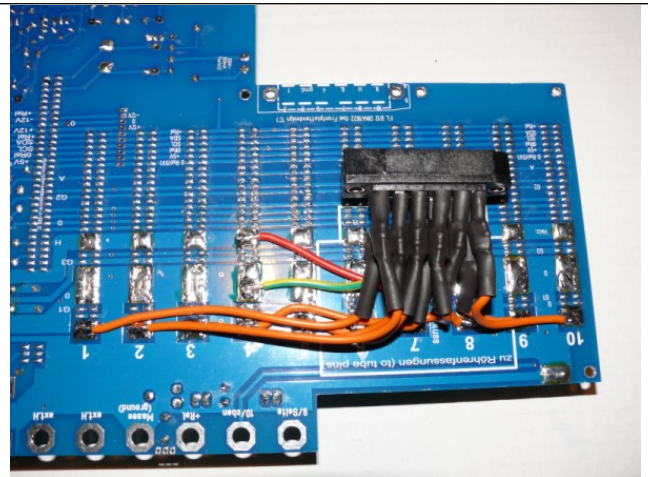
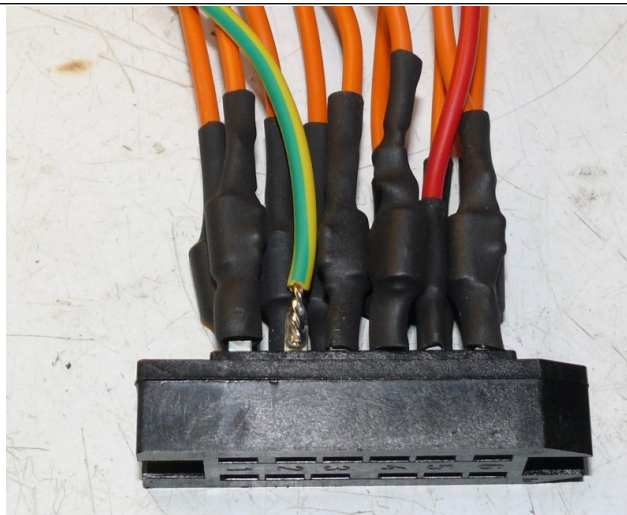
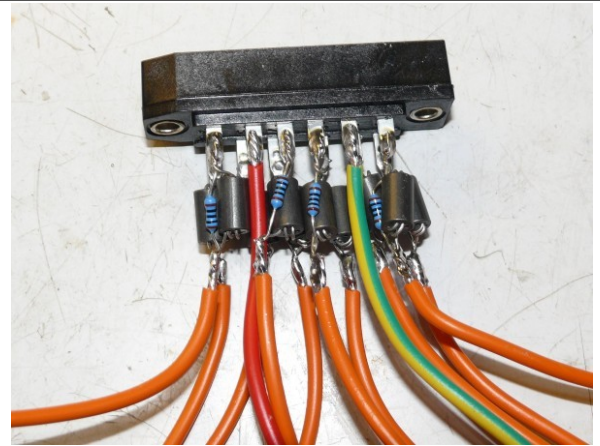
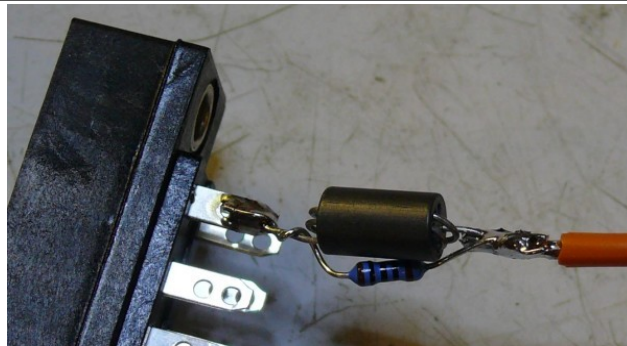

of the socket box
separate instructions:

[class_socketboxConnecti](#)

De
At
with
of ve
case



The socket box receiver is made from plastic (clear acrylic or similar) and an aluminum or plastic angle and has two rails to guide the socket boxes. Make sure that the bolts are not too long and don't touch the PCB or the main transformer. Make sure to bolt the main transformer to the front panel before bolting on the socket box receiver.

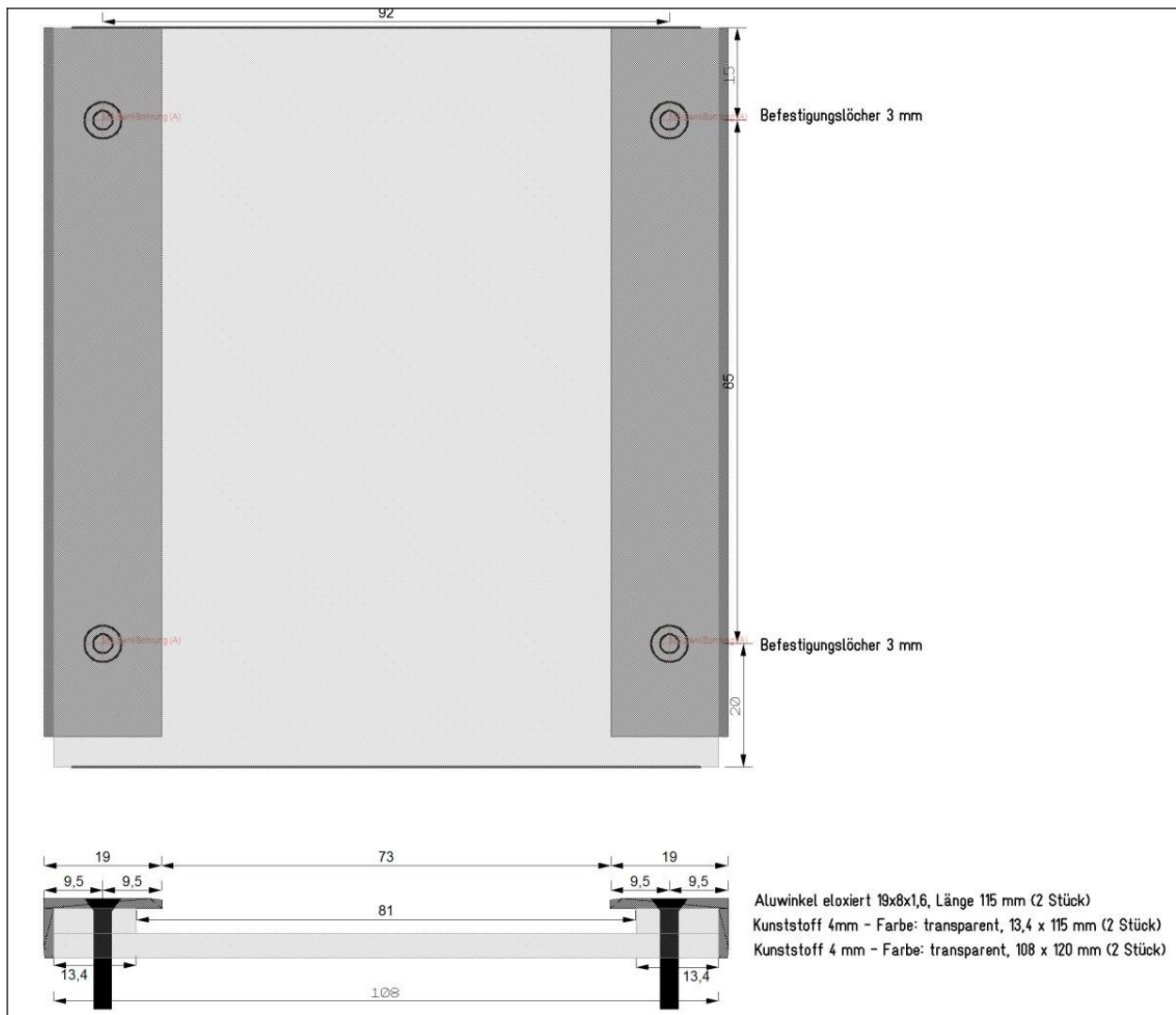

socket box receiver



socket box receiver components

Socket boxes

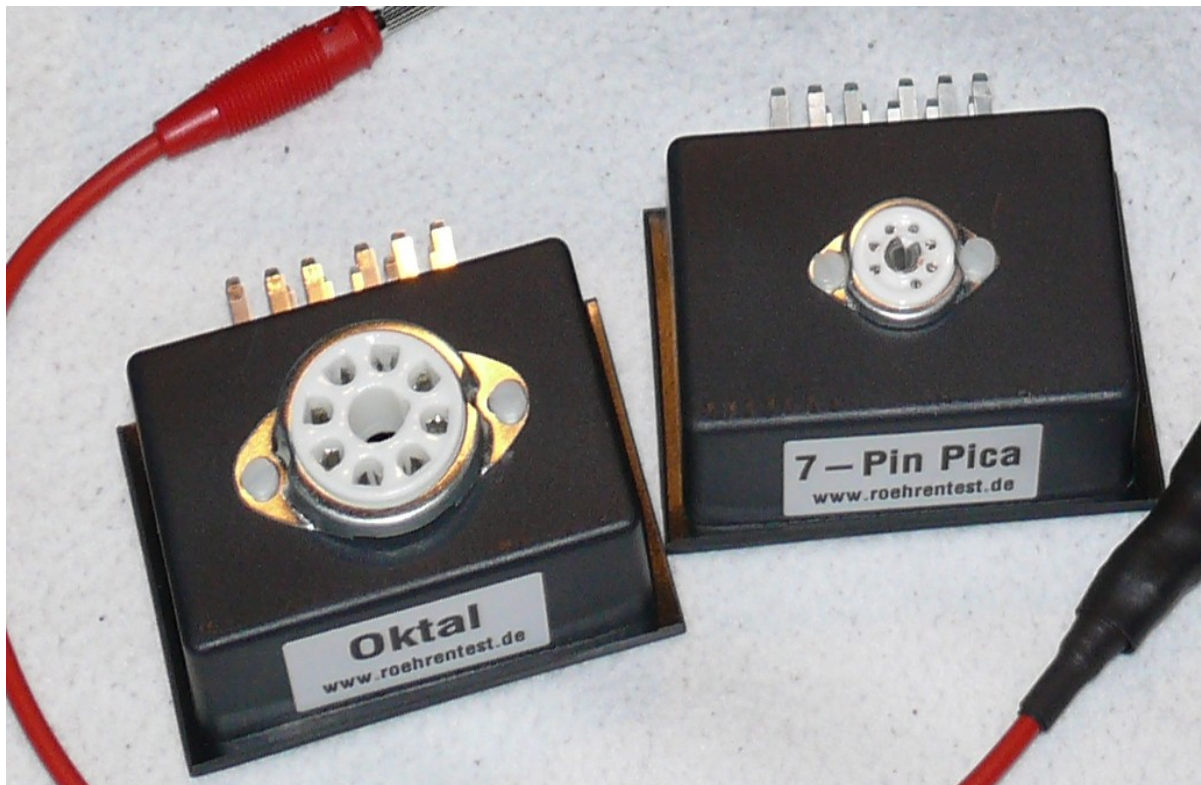

see: [Fassungsboxen_socketadapters.pdf](#)

Anode/Plate top connector cable



see: [Kabel Anodenanschluss anode cable D EN.pdf](#)

Safety laboratory jacks are mounted to the front panel for:

- Pin 9 and 10 – these are used for making connections to tubes with top connectors and for voltage regulator tubes (red)
- ground (black)
- 2 connections insert plate/anode voltage for connection of a extern output transformer (e.g. for soundtest) (blue)

Chassis:

A separate chassis is not necessary because all parts are attached to the aluminum front panel.

Heat sink:

I recommend to use my suggested heat sink. This heat sink has adequate cooling performance and exactly matches the front panel mechanically. The SK 479 75 SA (Fischer elektronik) extends along the whole housing's backside (40 cm) and has a cooling capacity of better than 0,5 K/W. If you do steady measurement of tubes with high power dissipation, then it can be useful using fans. Look at separate file [Luefter – fan EN.pdf](#).

The heatsink I supplied is undrilled. It requires threaded holes for M4 and M3. If the front panel and housing I suggested are used, the drilling diagram below can be used:

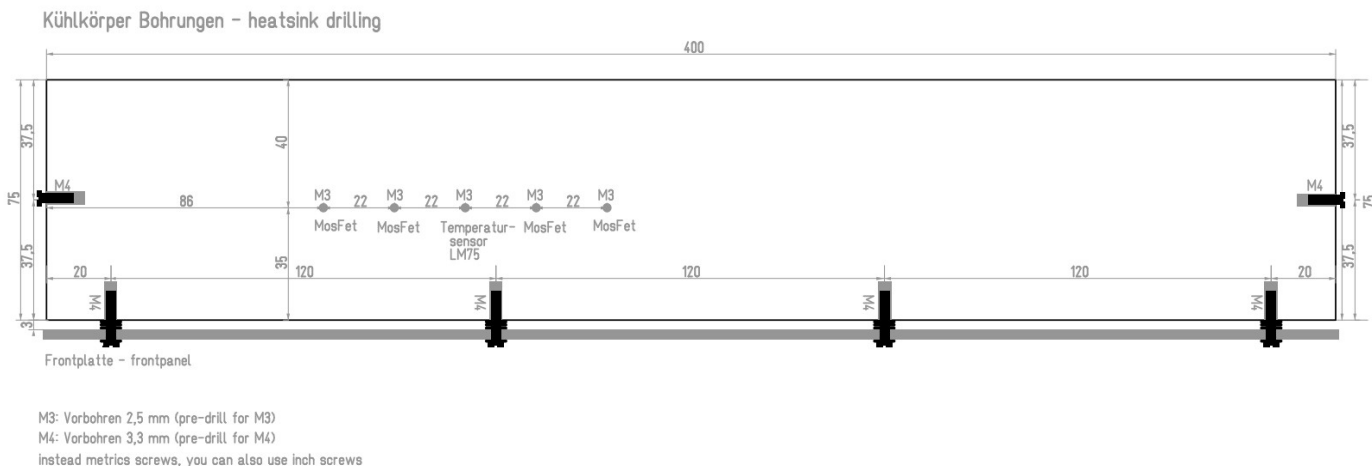

The drilling plan is also available as a PDF file on the CD-ROM (not in scale).

Assembling:

- front panel
- + main board
- + heatsink
- + cards

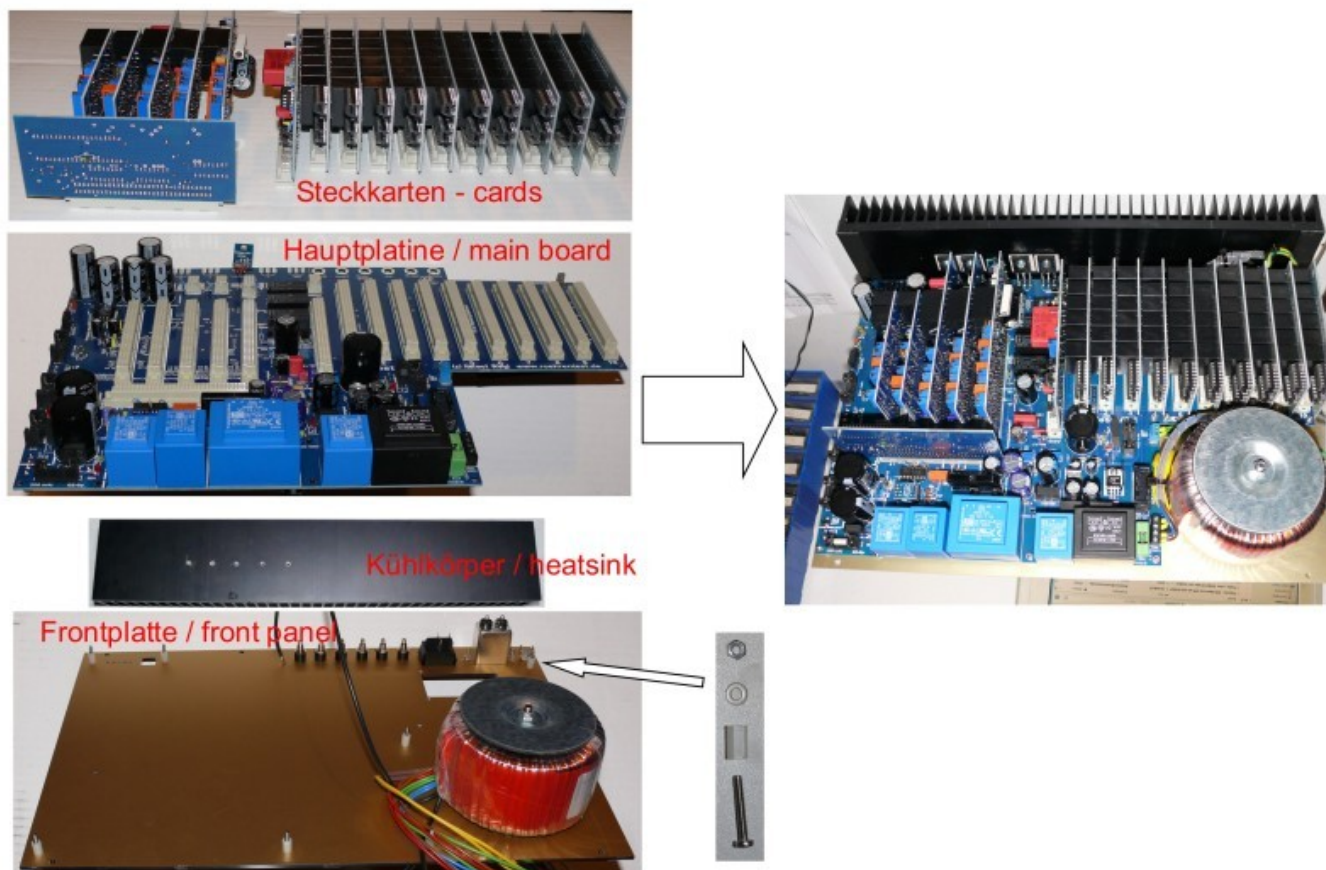

Info: The above pictures shows still the old transformers and older PCBs. The new main transformer needs no rubber and no metallic disc. The print transformers are omitted and in newer versions are replaced by another toroidal transformer (called “auxiliary transformer”).

The front panel with all electronics bolted to it can be put in an aluminum suitcase or some other suitable cabinet.

The above procedure is only a guideline. Of course, the main circuit board can also be mounted in a different housing or chassis. On my website there are numerous illustrations of RoeTests constructed by makers who have chosen different ways of building and different housing options.

Whatever you use, it should be some metal housing that is connected to ground for safety reasons and also to avoid RF radiations. Please pay attention to:

- Ventilation (heat must be able to escape)
- All metal parts that can be touched must be connected to ground!



Make sure that the front panel and the cabinet are connected to protective earth and also the central ground connection of the main PCB. Make sure safety is ensured for example make sure you can't touch anything that carries a high voltage, and be sure to comply with all the safety regulations and requirements of your country.

My RoeTest prototype:

Below are some pictures of my RoeTest :



Front panel professional quality, manufactured according to my specifications by a leading German manufacturer, 3 mm aluminum, under anodized print (smudge-proof and scratch-proof, oil- and thinner-resistant), also anodized edges, cutouts and drill holes perfectly fitting

Front panel design "A"

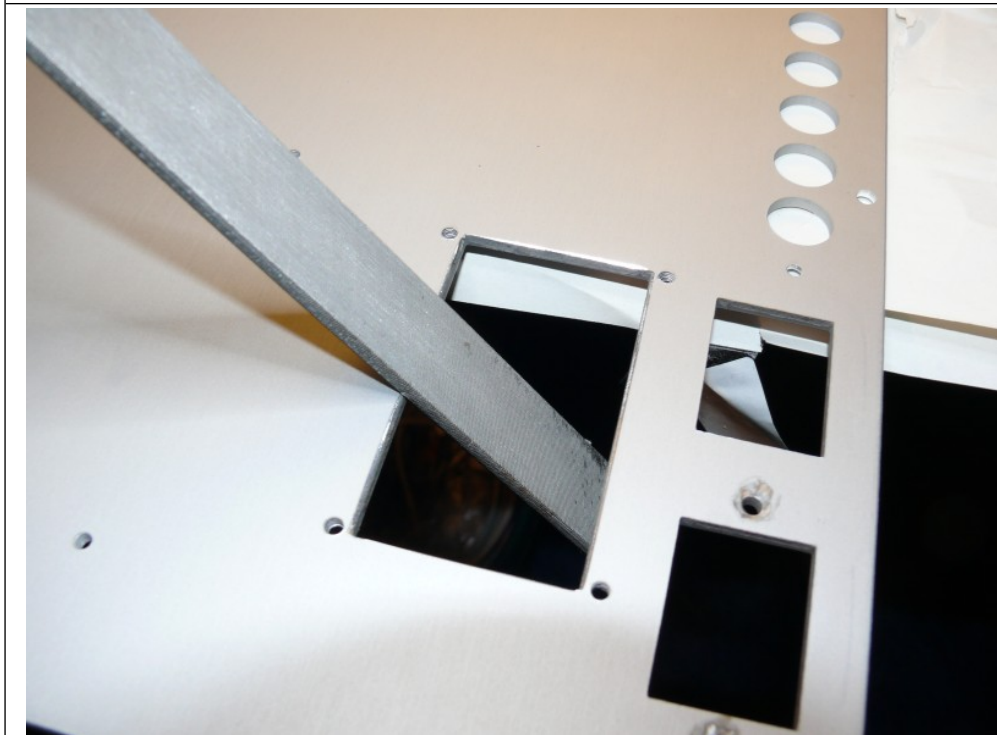

The back of the opening for the socket box connection should be rounded off slightly with the file so that the cables do not chafe through.

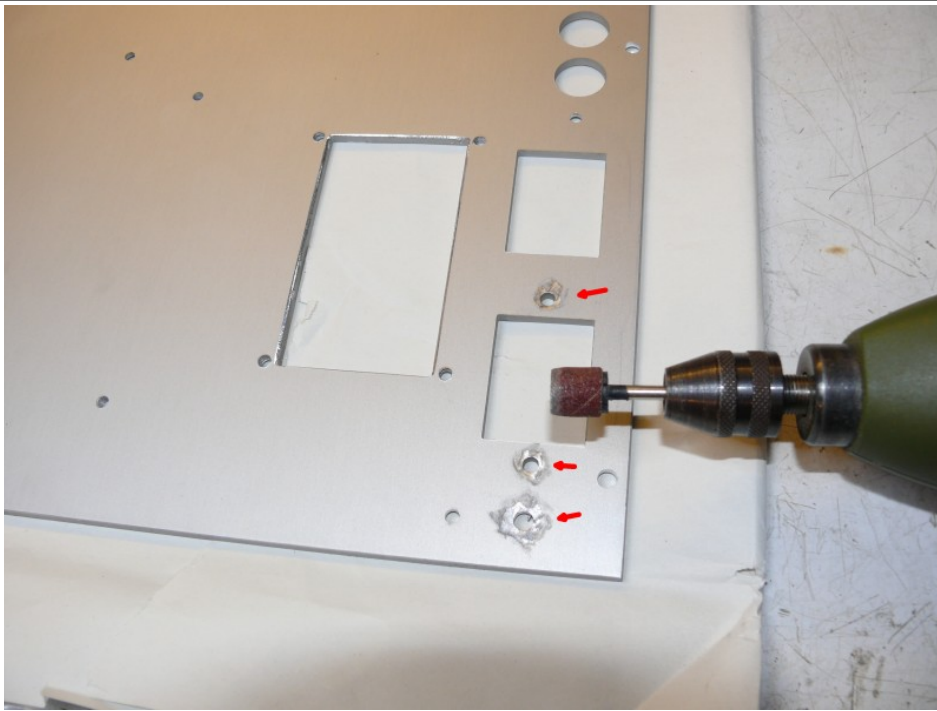

Grounding: All screws must have good electrical contact with the front panel. For this purpose, the anodized layer on the back must be sanded off at the marked points.

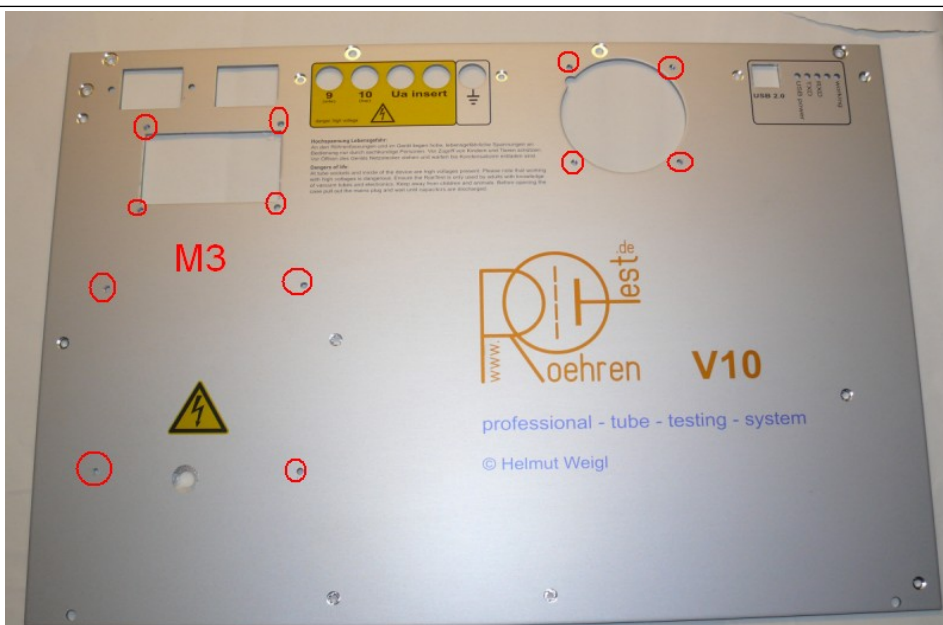
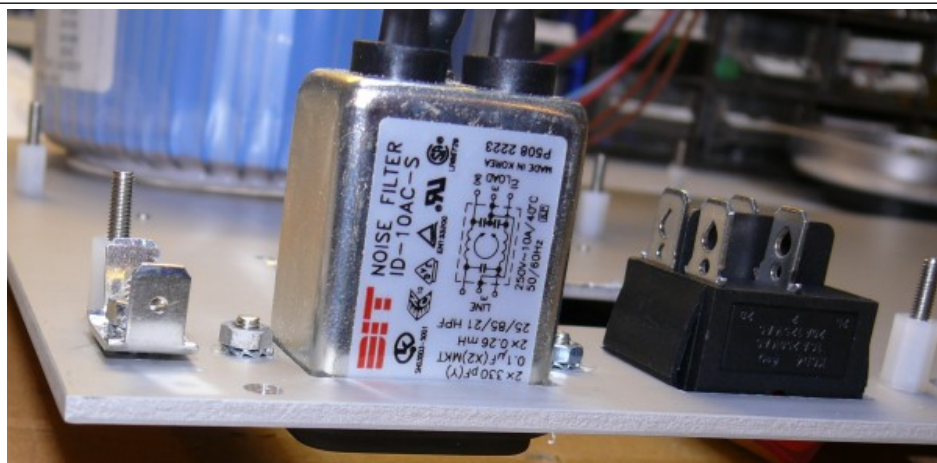

The anodizing also has to be removed from the M3 threaded holes so that the screws have electrical contact with the front plate (earth). To do this, re-cut the threads a few turns with a tap.

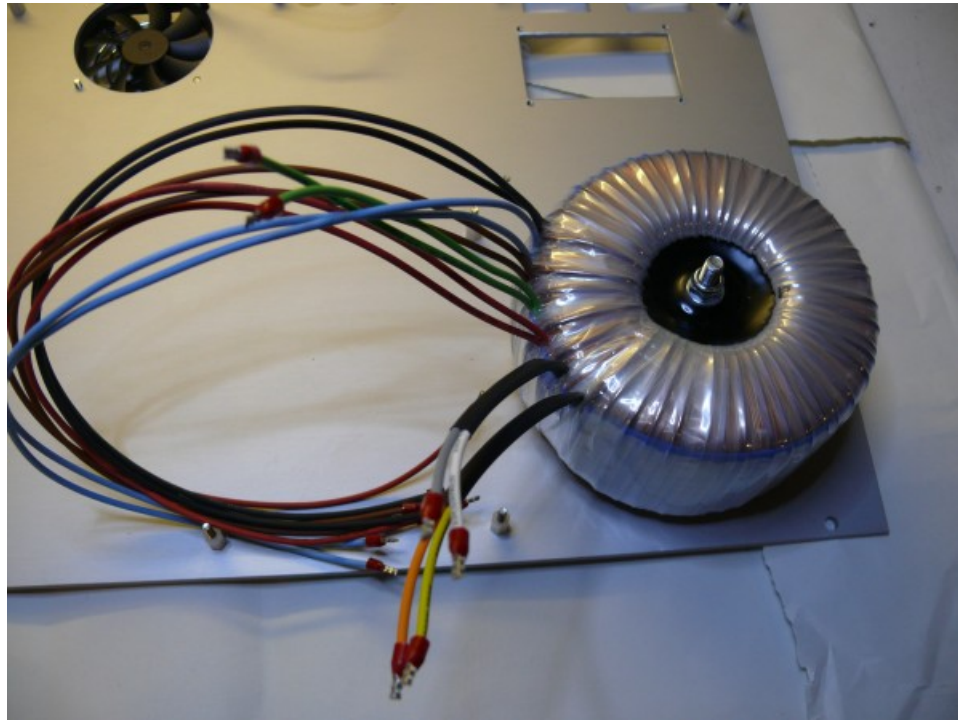

Backside with
M3 x 20mm
stainless steel
screws and
M3 x 10mm
distance bolts



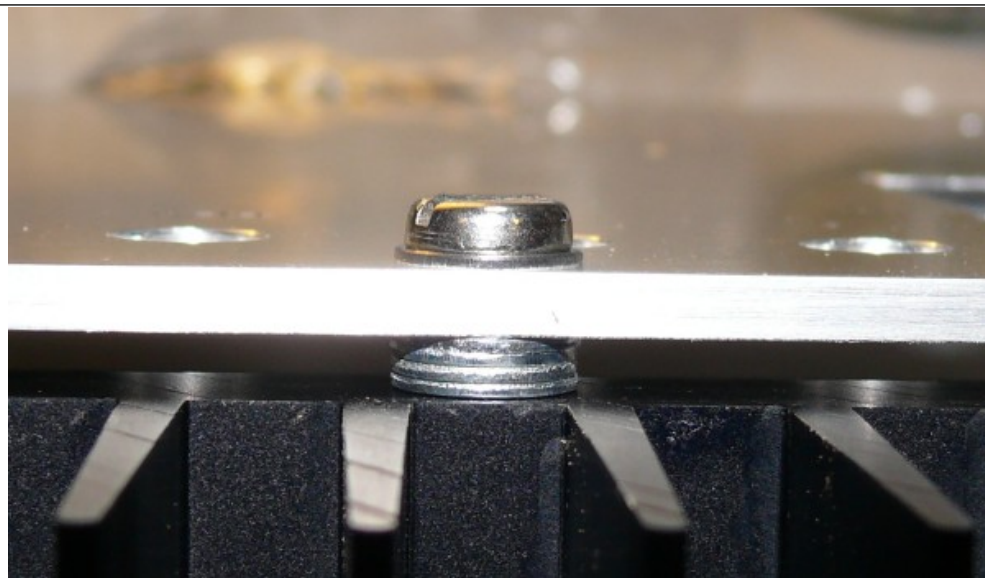

Attachment of heat sink to front panel with 4 screws M4x16.

4 washers per screw result in a vent slot between front panel and heat sink. The heat sink have to be drilled with M4 thread holes.



Attachment of mainboard to the front panel:

I recommend using 20mm long M3 stainless steel screws and 10mm spacers with M3 inner thread (= sturdier and cheaper than pressed-in bolts).

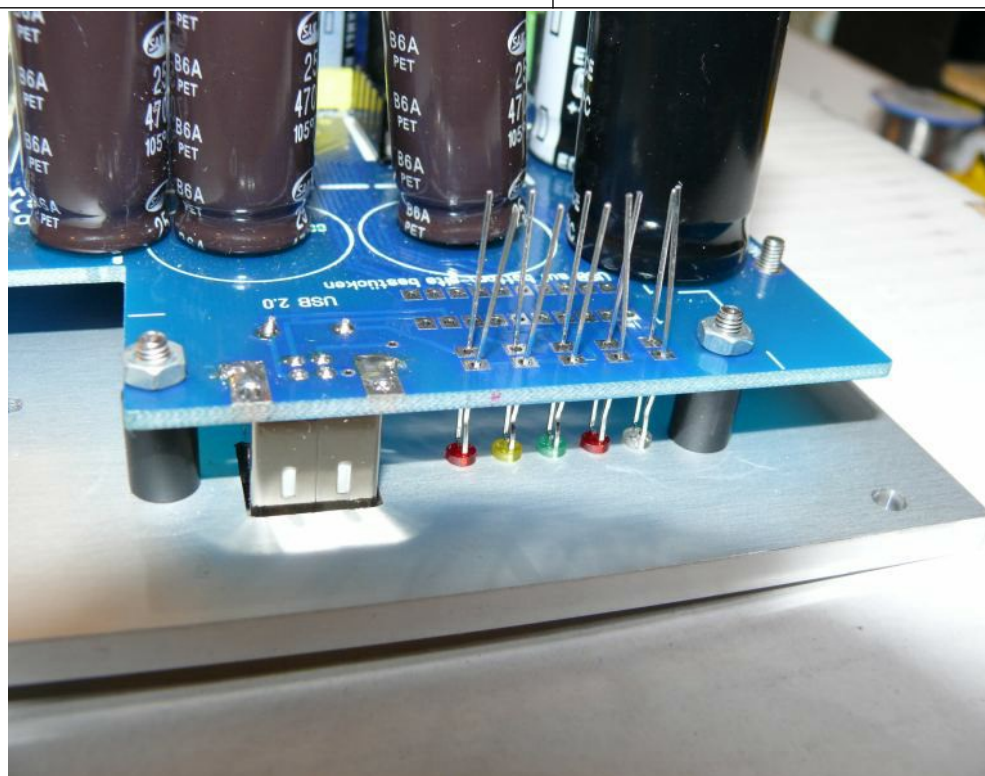

The LEDs are soldered in after the PCB is attached to the front panel so that it's easy to solder them in at the correct height. When installing the LEDs, the longest wire is the anode.

Mount USB jack and LEDs on mainpanel's bottom side!

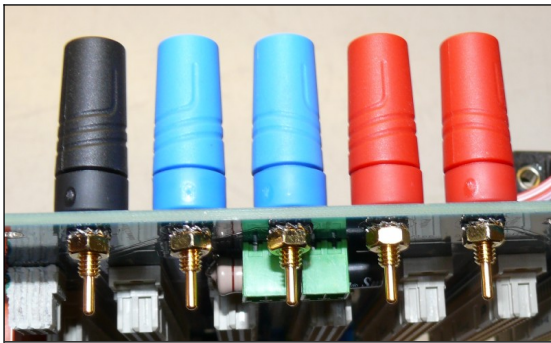

Attaching the sockets:

The jacks are screwed into the main board as shown below. Use toothed washers.

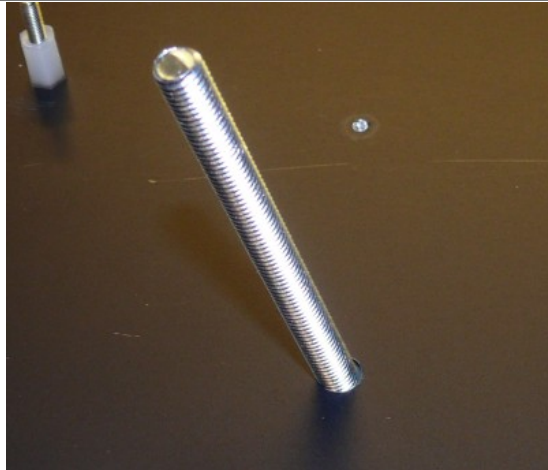

Bolt the main toroid transformer to the front panel.

Mount the toroidal transformer to the front panel as follows:

Insert a countersunk screw M6 x 80

Make sure that there are no protruding screws from the front panel in the transformer's area which could damage the transformer winding (socket box holder). Cut down those screws before mounting the transformer.



- Install the transformer
- Apply metal washer and fix transformer with a locking nut.

Caution: Tighten the locking nut carefully until the transformer holds reliably. Do not overtighten to avoid damage of the transformer winding!

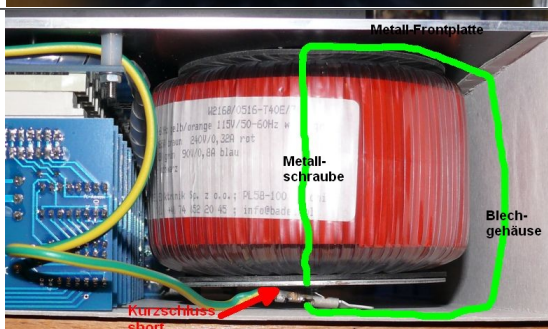



Failure Possibilities:

The upper end of the transformer's mounting screw may not touch any parts of the metal housing or protective ground.

This would create a shorted winding through the transformer causing a large current flow in this shorted winding.

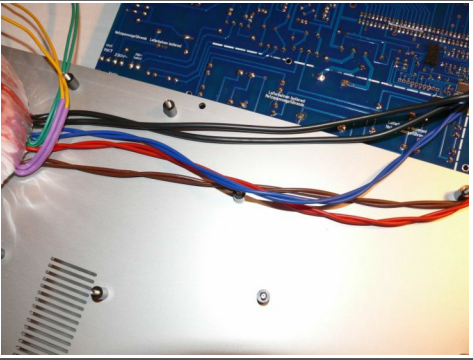
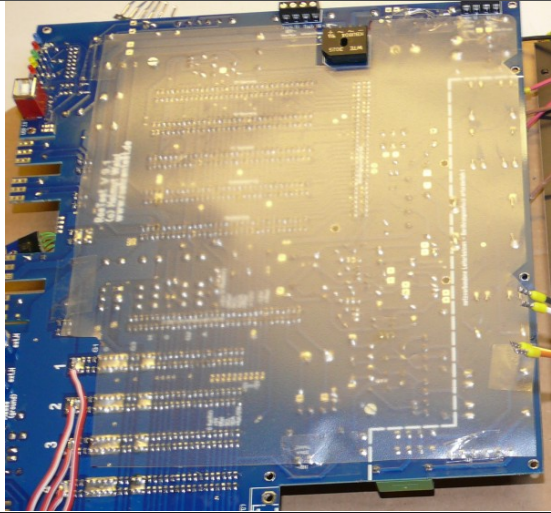
I encountered the following problem: When I connected the metal housing to the protective ground with a 6,3 mm flat connector below the transformer that connector touched the transformer's the mounting screw. This led to a **shorted, very low-resistance transformer winding**. The transformer got very hot without any load applied.

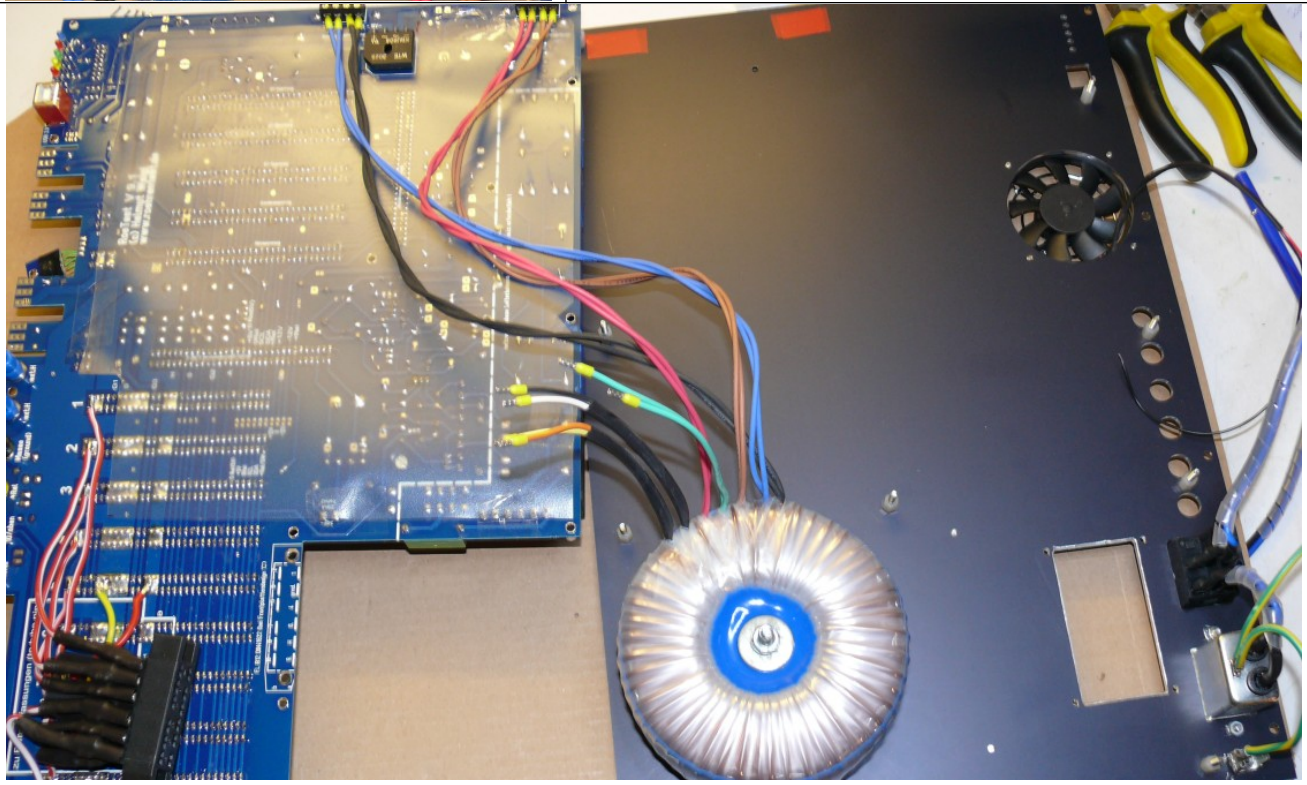
	<p>Main transformer connections to main PCB: route the wires in between the PCB and the front panel. You may want to twist the wires together, as this will help to suppress mains supply and RF frequency interference.</p>
	<p>In order to protect the wires between main board and frontpanel, please glue a plastic film on the bottom site of the mainboard (with tape)</p>
	<p>Solder the transformer wire connectors to the bottom side of the main board, for those wires routed in between the board and the front panel.</p>
	

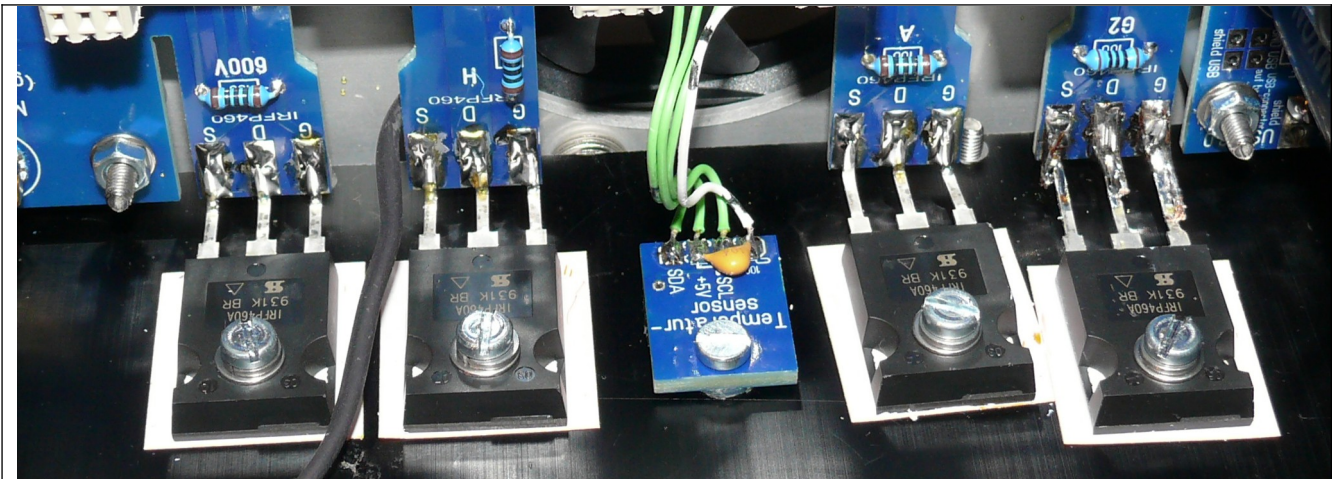

The MOSFETs must be insulated from the front panel or heat sink. I suggest Kapton insulation with only 0.15 K / W thermal resistance (KAP218). Insulation with poorer properties should be avoided because the MOSFETs could overheat before the heat is passed to the heat sink. These insulating films have a special coating that melts when heated. A thermal paste must not be used as this would impair the good properties of the insulating film.

The MosFets are attached to the heat sink using M3 x 16 mm screws, a snap ring and a washer. Tighten the screws carefully so as not to damage the MosFet.

The connection legs must be angled and soldered onto the solder pads from above. This means that the MosFets can be easily replaced later without removing the main board.

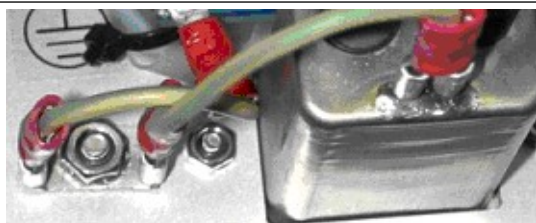

Connect ground wire coming from the mains to front panel, case and PCB with wires. This way all metal parts that can be touched from the outside are grounded.

Use an extra screw on the front panel for grounding! Remove the anodized layer below the screw.

Connecting with the bolts only is insufficient. They can break.

Attention: Sometimes the bolts have no connection to the front panel at all, especially if they are only stucked.

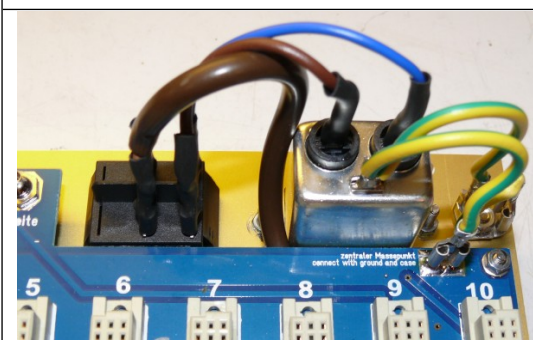

There is a 6,3mm flat connector for connecting the protective earth to the mainboard.

It is a good idea to use a mains filter (instead of just a simple mains supply socket).

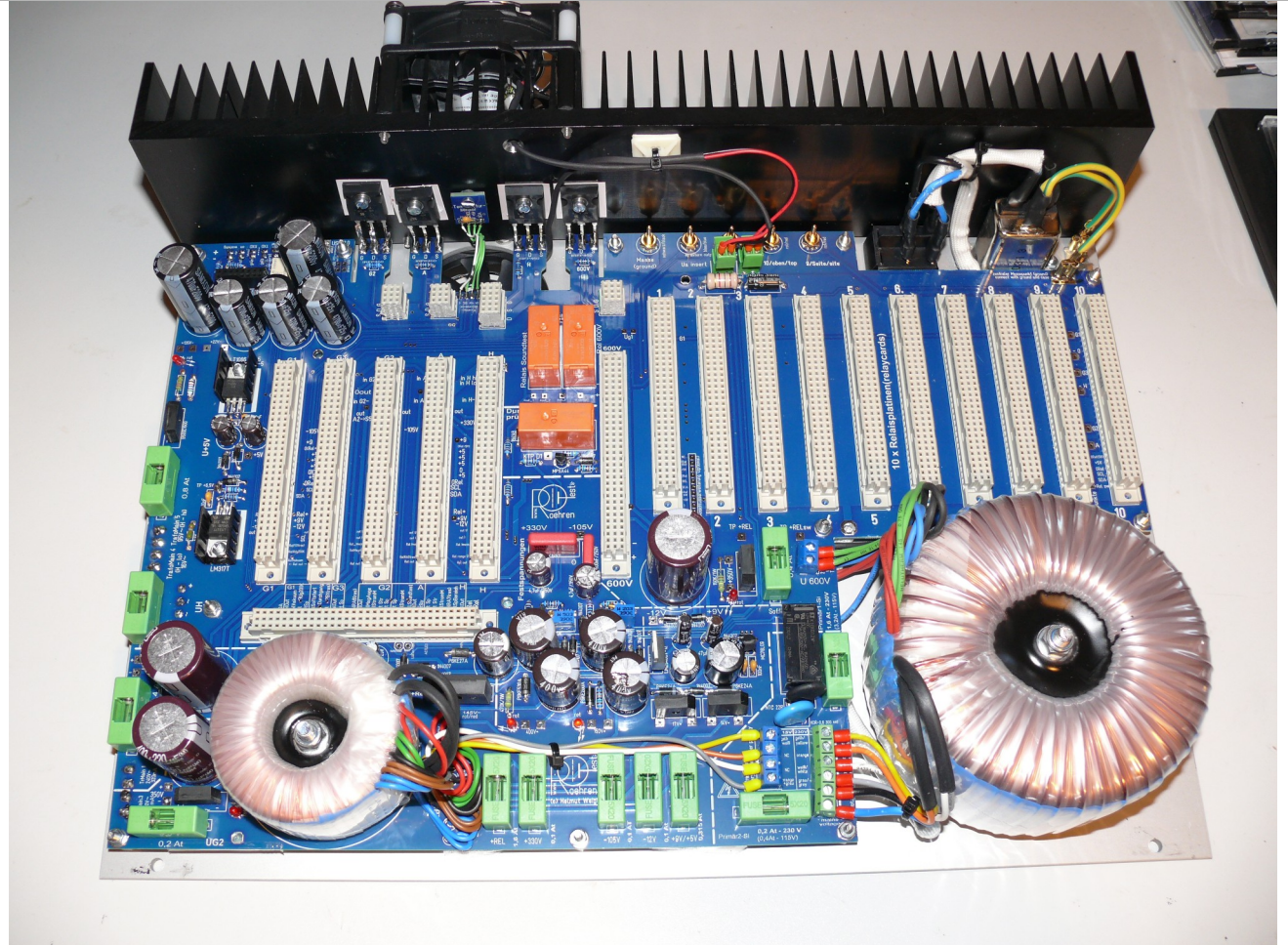

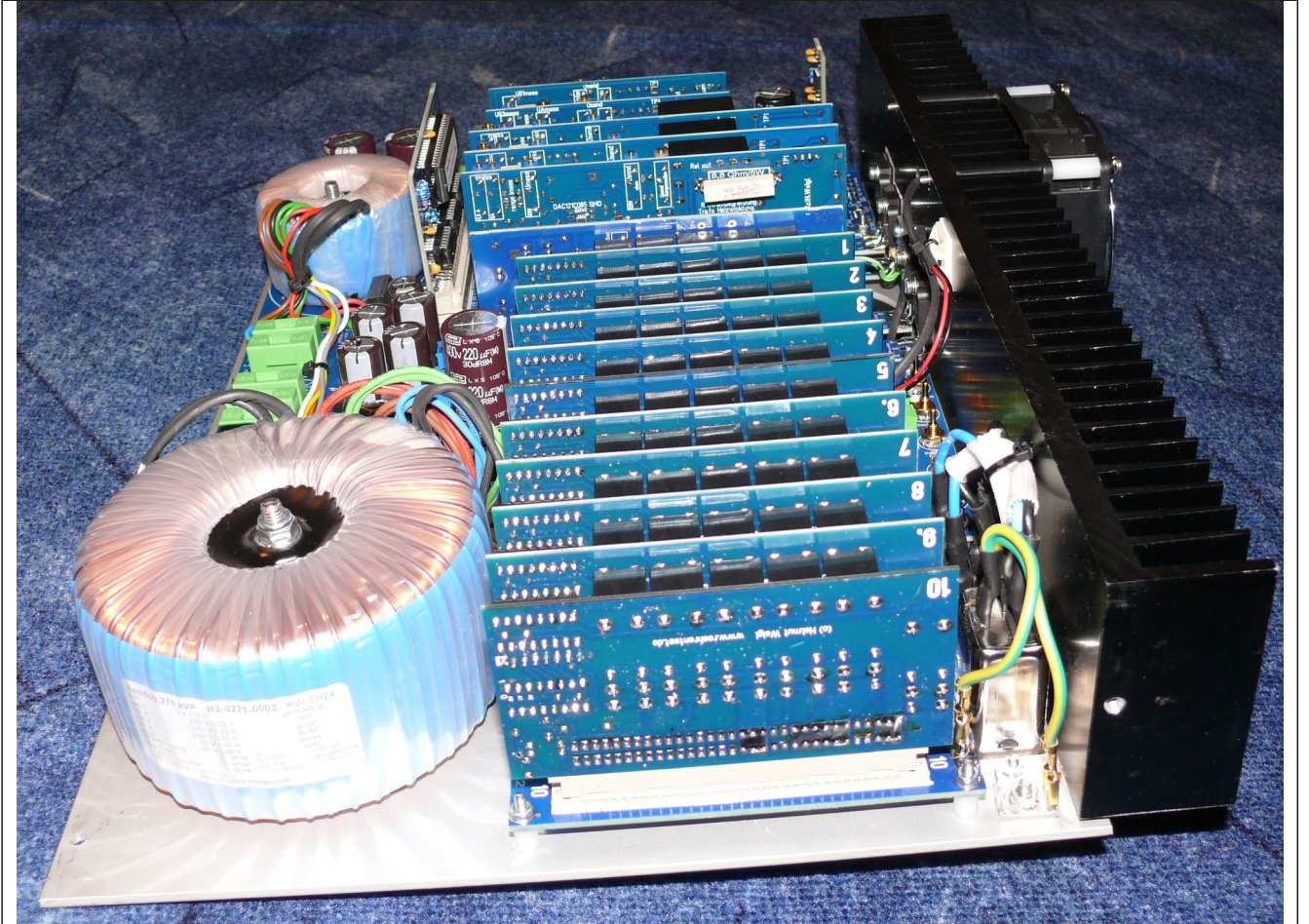
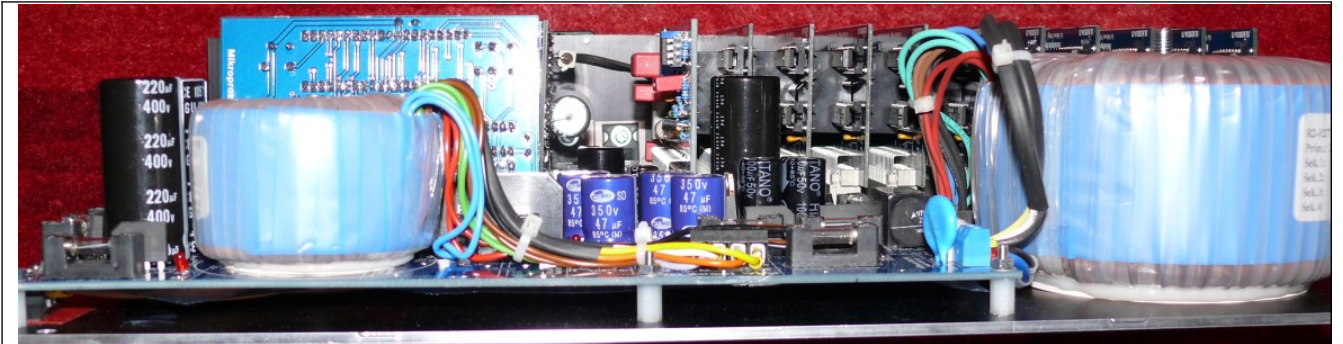

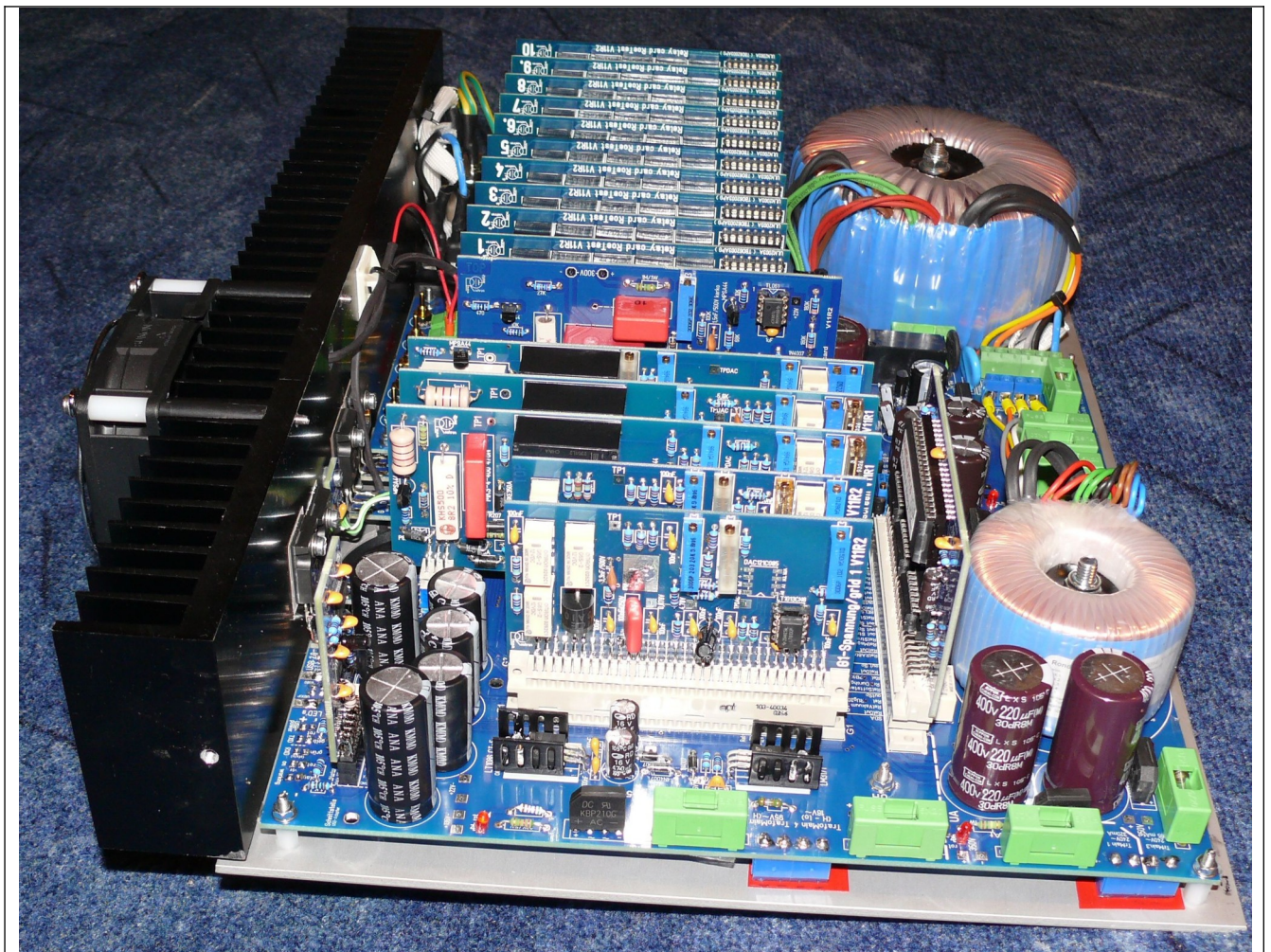

The complete unit can be mounted into an appropriate enclosure for instance a tabletop cabinet:



Wiring:

The remainder of the wiring can be done quickly. Make sure you use quality wiring with good insulation and a sufficient wire gauge/width:

1. From the power cord connector with an RFI filter to the power on switch and to the main PCB
2. Connect main transformer to mainboard (twist the wires)
3. Wires from mainboard to tube socket receiver (1.5 mm² wire gauge/thickness). Solder the wires to the mainboard's bottom side. At the socket box receiver side I used RF attenuators for each of the wires. These consist of a ferrite RF choke with a parallel 100 Ohm resistor (use only low-inductance film resistors). The attenuators are insulated with heat shrink tubing.
4. Temperature sensor PCB
5. Protective earth connection from power cord connector to front panel. Use an extra screw for this connection. Remove the anodized layer below the screw.
6. Protective earth connection to the mainboard (6,3 mm connector)
7. Protective earth connection to the metallic case

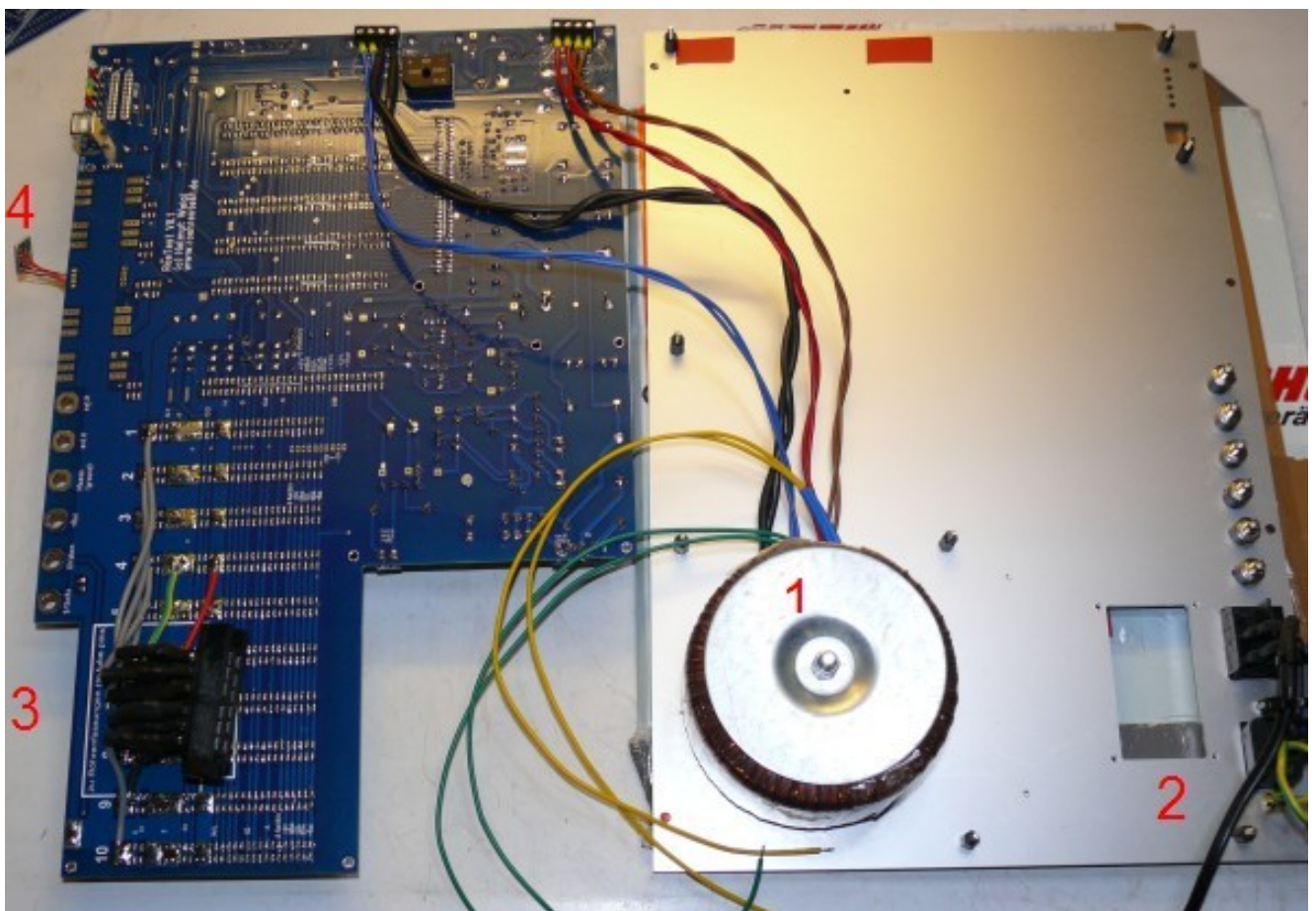

(Info: The picture is showing a older main transformer. The actual transformer is fasten without washer)

Important: keep all wires to the socket box receiver and to the MOSFETs as short as possible. The longer the wires, the more risk there is for oscillations with certain tube types.

In my devices there are only a few inches from the back of the mainboard to the socket box receiver. The MOSFETs are soldered directly to the mainboard. Within the socket boxes I have shortest wire routing possible (when only one socket per per box is installed). With this setup, I have no oscillation problems even with very high gain tubes.

Fuse table:

In my unit used the following fuses (all slow blow):

Primary 1:	1,6 A (230V)	3,2 A for 115V mains voltage
Primary 2 (only if toroidal transformer is used)	0,2 A (230V)	0,4 A for 115V mains voltage
Secondary:		
Heater supply low range:	6,3 A	
Heater supply high range:	0,8 A	
Anode supply:	0,4 A	
600 V board supply:	0,4 A	
G2 supply:	0,2 A	
Relay power supply:	1,6 A	
+9V/+6,5V/+5V	0,315 A	
-12V	0,1 A	
+330V	0,1 A	
-100V	0,1 A	

All fuses are located on the mainboard.

On the main board is a VDR with a voltage of 300V. If you build your device for a mains voltage of 115 V, then you should use a type with a voltage of about 170V (e.g. Epcos EPC B72214-S17),

First time power on / test procedure:

Please check all the wiring (again) before you switch on power for the first time.

My recommendation is to test parts of circuits separately. You can remove and insert various fuses and PCBs to do that.

Important note: when you make changes or fix something TURN POWER OFF and WAIT FOR THE FILTER CAPACITORS TO DISCHARGE. Also don't insert or remove PCBs with power switched on or with charged filter capacitors!

The following sequence of steps is recommended:

- First, with no PCBs or fuses inserted in the mainboard, test all the power supplies connected to the mains and make sure the no-load (idle) voltages are not too high (they should not exceed the voltage limits of the filter capacitors).
- Check regulated +9V, +6,5V, +5V, -12V, unregulated 12V relay supply, set the -105V using the trimmer pot and set the +330V using the trimmer pot
- Then insert the secondary fuses in the heater, anode and G2 power supplies and measure the output voltages. Test pins can be soldered to the main PCB at the indicated locations. They can be used to discharge the capacitors and/or measure the voltages. The idle voltages for the A, G2 and 600V supplies should be approx. 360V.
- For the next steps switch off the anode, G2 and heater supplies by removing their secondary side fuses.
- Insert the microcontroller PCB. When the power is switched on, the working/on indicator LEDs should blink a few times, indicating the PIC microcontroller is starting up. It should now be possible for the PC software to communicate with the PIC microcontroller via a USB cable. Make sure all necessary software drivers are properly installed, see the separate user manual for instructions. The PIC should now respond when it gets commands. If you start the "testing for shorts" test the working indicator LED should blink.
- With +5V and relay power on, open the relay test function: PC-Software->Options/Test->Relays, and test the check for continuity relay on the main board.
- Now insert the relay PCBs (make sure the correct PCF8574(A)) chips are inserted) and test the relays: PC-Software->Options/Test->Relay-PCBs, one card after the other, and test each of the pin relays.
- Insert the remaining PCBs (still without secondary side fuses for A, G2 and heater) and test the relays (using the PC-Software->Options)
- Test the DAC121C085s on the H, A, G1, G2 and G3 boards: Select PC-Software->Options/Test->sending voltages. With the slide control you can set the DAC121C085 output for each of the boards. Measure the voltage on Testpoint 'DAC' on the cards, you should be able to set it from 0 to +4,7V using the slide control.
- Now check that you can control the G1 and G3 output voltages using the PC software. Connect your meter to test point 1 on these boards. Note that the boards are not yet calibrated.
- Next reinsert the secondary side fuses for the A, G2 and H card supplies and test whether you can set the output voltages (test point 1) on each card.
- And finally insert the 600V PCB which has a 300V fixed output. Measure the output between the two test points on the card.

Calibration:

Before calibration the RoeTest should be completely assembled and all circuits should be operational. The first step is a rough calibration of all the trimmer pots. For a final calibration the unit must be fully warmed up (which takes about 30 minutes at room temperature) and the calibration steps repeated. I recommend recalibration after the unit has been used for a few days and then at regular intervals.

Before calibration the software must be setup for the proper hardware type

This can be done using predefined Presets. You can find them at Optionen->Einstellungen->Datensicherung (Options->Settings->Data-backup).

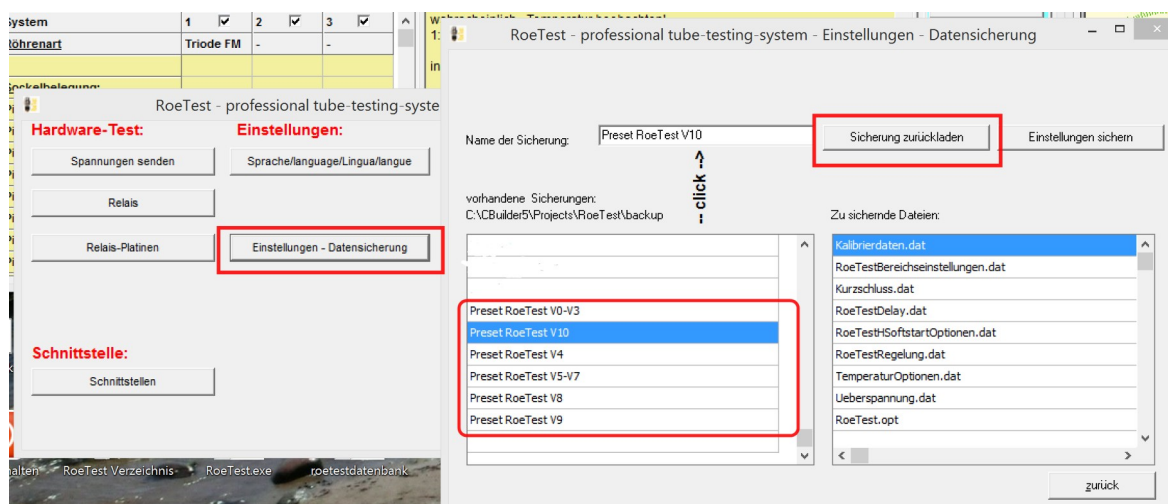

The 'Presets' are only coarse starting values. When you have finished all settings please make your own data backup and use your backup in the future.

The data backup is located in the directory

c:\roetest\backup\mydatabackup (or whatever you named the backup)

It is best to copy this directory to a safe place and store it (e.g. on a USB stick). If necessary, you can restore the files or transfer the settings and calibration data to another computer.

Calibration Assistant

Starting with hardware version V9 and software version 10.0.0.0 there is a calibration assistant available. This will guide you step by step through the adjustment. There are also pictures with measurement points and the position of the trimmers.

Starting with software version 10.2.7.0 the special calibration box is supported.

You can find the calibration assistant as follows:

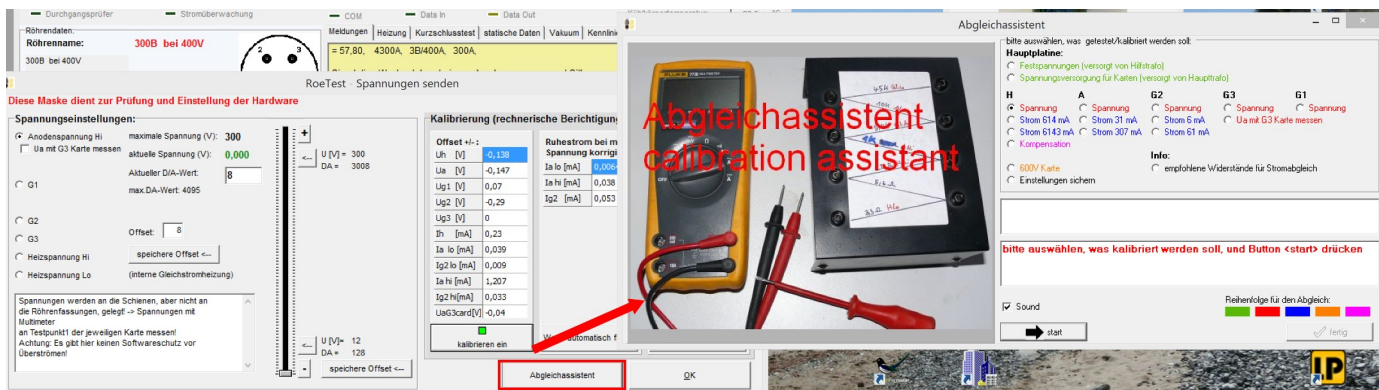
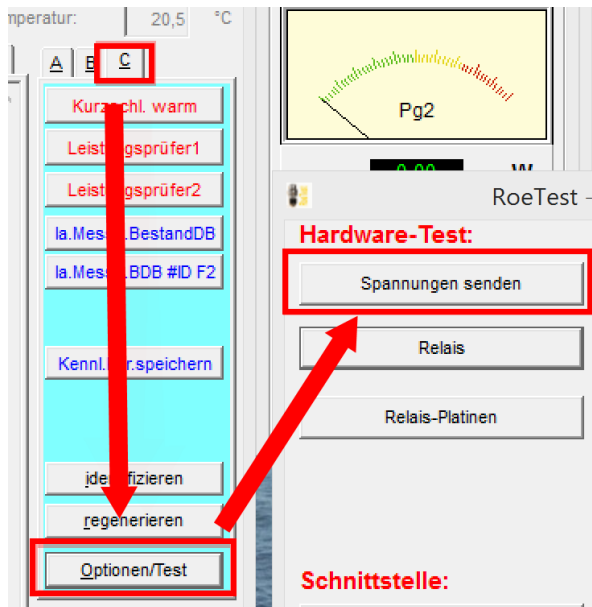

For calibration you need:

- Multimeter
- Screwdriver
- special calibration box (see [Abgleichbox calibration box D_EN.pdf](#))



Karte card	Bereich range	Kalibrierung bei calibration at	ext. Widerstand external Resistor	P minimum P resistor minimum	P empfohlen P resistor recommended	Ua
		[mA]	[Ohm]	[W]	[W]	[V]
H	6A	2000	3,3	13,2	25	6,6
	600 mA	300	22	1,98	5	6,6
A	300 mA	150	1000	22,5	25	150
	30 mA	25	10000	6,25	9	250
G2	60 mA	30	4700	7,5	9	250
	6 mA	5,5	47000	1,375	5	250

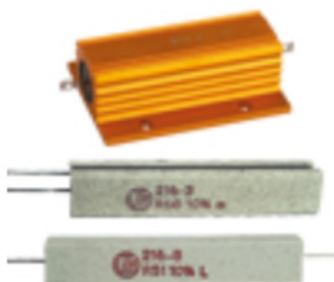

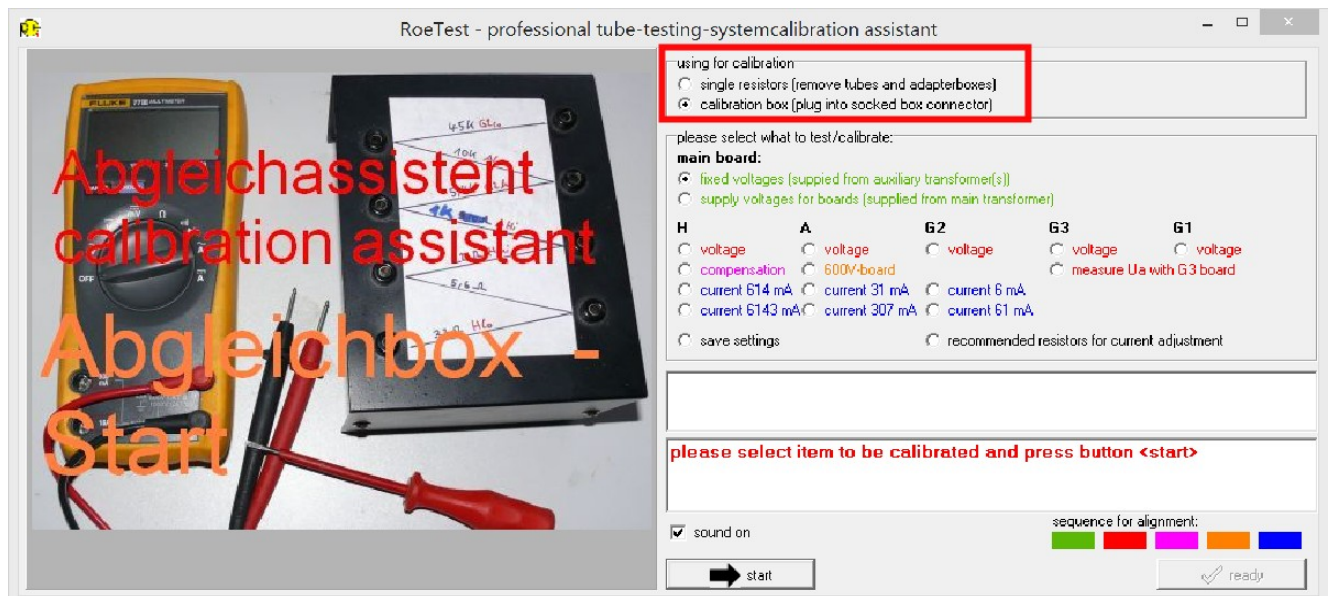

Proceed as follows:

First select whether you use the special calibration box or single resistors. Then calibrate in the following order:

1. Check/align the fixed voltages
2. Align the voltages on the cards
3. Compensation of the heater voltage card
4. 600V card
5. Align the currents on the cards

Press the associated radio button and then click the <start> button. Follow the instructions and the images supplied from the calibration assistant.

It is also possible to perform a manual calibration without calibration assistant and without calibration box, which I do not recommend due to the effort involved.
(see: [Abgleich manuell_EN.pdf](#))

Current Limiter:

The RoeTest uses hardware current limiters to limit the current output as per the table below:

	Continuous current	Max. current	Current limiter kicks in at
Heater low range	5000 mA	6000 mA	ca. 6000mA
Heater high range	500 mA	600 mA	ca. 670 mA
Anode/plate	250 mA	300 mA	ca. 350 mA
G2	50mA	60 mA	ca. 68 mA

Note that the actual values at which the current limiter takes effect depend on the tolerances of the semiconductors and the resistors. The transformer used should be able to continuously deliver about 1.25 times the maximum current.

Testing the hardware current limiters: (use manual control mode)

Test the heater, anode and G2 voltage boards, one after the other:

-> connect a suitable resistor that can handle the required power, or if you don't have one use for instance a light bulb, to test point 1 and ground and increase the output voltage until the current limiter kicks in. Do this only for a short period of time! Output voltage should decrease when the current limiter kicks in and the output current should not increase further.

Testing the voltage regulation of the H, A and G2 boards: (use manual control mode)

From Roetest 4 onwards electronic voltage regulation is used. Output voltages must remain stable as long as the output current limiter does not kick in. Connect a resistor and verify that the output voltage is constant.

Continuity test circuits:

The continuity test circuit is used in various tests – for instance for the filament test or when testing for shorts.

Verify the function of the continuity circuit with no tube inserted. The continuity test circuit uses the S2 (A) and S4 (G2) rails. When the “check for continuity” relay is switched on, 5V is fed through a resistor and a diode (for protection), connected to the S4 rail and should be measurable. Switch the relay on using the software as shown (PC software->Options/Test->Relays->check for continuity). Now connect the S2 and S4 rails.

This can be done by removing a relay card and using a wire to connect the S2 and S4 rails in the card socket on the mainboard. Don't forget to switch off the RoeTest before removing the card! The rails are also accessible at the measuring points between relay cards 9 and 10. This causes the MPSA44 to be switched on and signal B7 at the PIC goes from hi to lo. The software should indicate that by illuminating the software LED “check for continuity” as shown below.

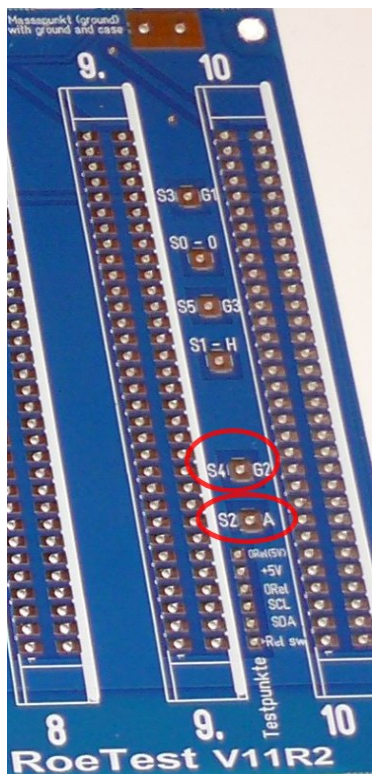

Note: If the check for continuity circuit doesn't work reliable, you may have voltages somewhere that are not properly connected to ground. Make sure the A, G2 and H boards are inserted when testing this and that the secondary side fuses for the power supplies of these cards are inserted. If you have the 600V board inserted its negative input must be connected to the main ground through a 0,47 μ F/630V capacitor.

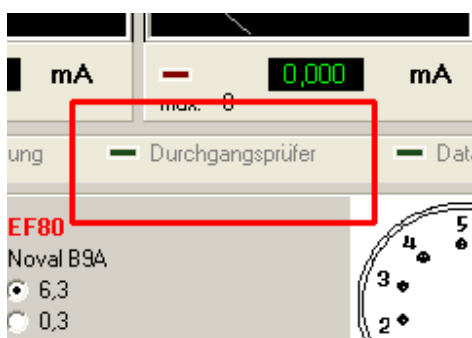

Now if everything works correctly and calibration has been done properly you can insert your first tube and test the tube!

Closing remarks:

When you have successfully built the RoeTest you'll have a tube tester you can't find elsewhere. If you don't count the hours to build it, it'll cost you less than a well maintained vintage tube tester. But you can do a lot more with the RoeTest and it is much simpler to operate.

Good luck with building the RoeTest and have fun testing tubes.

Helmut Weigl

Additional documentation:

The following documents are on a CD-ROM that can be ordered from me:

- complete schematics and placement plans
- components database
- more pictures
- PC-Software (measurement software, drivers, database)
- many documents and manuals for instance this manual.

The programmed PIC microcontroller can only be obtained from me.

As long as supplies last, you can also order the PCB set, the transformers and some special components from me.

You can find more information and software updates (published irregularly) on my website

www.roehrentest.de